



**in**  **PEST**<sup>®</sup>  
 WE **IPM** YOUR WORLD

inPEST<sup>®</sup>

🇬🇧 CATALOGUE 2026

# CATALOGUE 2026

PROFESSIONAL MONITORING



**in**  **PEST**<sup>®</sup>  
 WE **IPM** YOUR WORLD

Via A.B. Sabin 31 - 20019 Settimo Milanese (MI)  
[www.inpest.it](http://www.inpest.it)

**GEA**   
 The Green Factory



**GEA**   
 The Green Factory

# CATALOGUE 2026











WWW.INPEST.IT

# TABLE OF CONTENTS

## CATALOGUE inPEST

For a smart and sustainable Pest Control	4
Our certifications	5
TEAM inPEST	6
GEAforma	8

## inPEST PRODUCTS

 PHEROMONES AND SPECIFIC ATTRACTANTS	11
 FOOD INDUSTRY CRAWLING INSECTS	27
 FOOD INDUSTRY FLYING INSECTS	41
 METAL-DETECTABLE PRODUCTS	51
 CRAWLING INSECTS LINE	58
 MICE AND RATS	69
 FLIES, WASPS AND FRUITFLIES	91
 ILTS, LED UV TRAPS, UV TUBES AND GLUE BOARDS	96
 BIRD REPELLENT	110
Sales Terms	112
Customization	113
Alphabetical index	114

# FOR A SMART AND SUSTAINABLE PEST CONTROL

inPEST® is a GEA's Pest Management brand. A brand which is specifically designed for the Trained professional in the world of monitoring and IPM.

inPEST® wants to be a key brand in the world of sustainable / green pest control in Europe, ensuring hygiene and safety throughout the supply chain in the most effective way possible and in full respect of the environment.



## OUR CERTIFICATIONS



**UNI EN ISO 9001:2015**  
Quality management systems

**ISO 45001:2018**  
Occupational health and safety management systems

**UNI EN ISO 14001:2015**  
Environmental management systems

**UNI ISO 21001:2018**  
Management systems for educational organizations

**ISO/IEC 27001:2022**  
Information security management system

# TEAM inPEST

## Sales



**Matteo Costamagna**  
*Sales Director*

✉ matteo.costamagna@geaitaly.it  
☎ mobile +39 338 931 3451

For products' information and sales' terms and conditions.



**Natalia Brondi**  
*International Key Account*

✉ natalia.brondi@geaitaly.it  
☎ mobile +31 642357896

For products info & sales terms.



**Riccardo Ceron**  
*Key Account inPEST*

✉ riccardo.ceron@geaitaly.it  
☎ mobile +39 3664123557

For products info & sales terms.

## Administration



**Giuliana Ferro**  
*Administration/ Control Group Area Manager*

✉ giuliana.ferro@geaitaly.it  
☎ tel. +39 02 335 148 90

For information on payments and credit management.

## Customer Care



**Sara Airaghi**  
*Customer Care Executive*

✉ sara.airaghi@geaitaly.it  
☎ tel. +39 02 335 148 90

For the management of orders in Italy and abroad and to know delivery times.



**Noemi Kerstens**  
*Customer Care Executive*

✉ noemi.kerstens@geaitaly.it  
☎ tel. +39 02 335 148 90

For the management of orders in Italy and abroad and to know delivery times.

## Quality & Regulatory



**Nadia Zini**  
*Quality & Regulatory manager*

✉ nzini@geaitaly.it

For certifications and regulations.



**Vittoria Andreasi**  
*Quality & Regulatory Assistant*

✉ vittoria.andreasi@geaitaly.it



**Silvia De Milato**  
*Executive Research*

✉ silvia.demilato@geaitaly.it



**Marco Caimi**  
*Research Manager*

✉ marco.caimi@geaitaly.it

For the recognition of insects, for information on tests efficacy and laboratory.



**Chiara Canali**  
*Executive Research*

✉ chiara.canali@geaitaly.it

## Marketing



**Valentina Antoniazzi**  
*Marketing Manager*

✉ valentina.antoniazzi@geaitaly.it  
☎ mobile +39 360 106 3720

For info on advertising, catalogue and web site.



**Anna Di Matteo**  
*Graphic Designer*

✉ anna.dimatteo@geaitaly.it



**Rosaria delle Cave**  
*Web&Graphic Designer*

✉ rosaria.dellecave@geaitaly.it

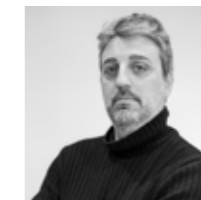

**Guido Ansaldi**  
*Media Manager*

✉ guido.ansaldi@geaitaly.it  
☎ mobile +39 338 711 8873

For any information contact [orders@geaitaly.it](mailto:orders@geaitaly.it)  
or your sales representative.  
Our PEC address is: [geapec@registerpec.it](mailto:geapec@registerpec.it)

## A SINGLE NAME FOR TRAINING



Provides training courses for our three sectors



PROFESSIONAL  
MONITORING



HOME AND GARDEN



PROFESSIONAL  
AGRICULTURE

GEAforma aims to consolidate its role as your reference for trainings in the world of pest monitoring. Our training proposal offers high quality online and presential courses and professional development programs, aimed at enhancing the skills of those involved in the sector. An opportunity to grow professionally and to keep pace with market developments.

We offer specific course to help you reach your goals effectively. All training courses are organized following a strict quality standards certified by UNI ISO 21001:2018, ensuring maximum reliability.



COURSES

TRAININGS

ONLINE OR IN PERSON



DISCOVER MORE



<https://geaitaly.it/geaforma/>

## PHEROMONES AND SPECIFIC ATTRACTANTS

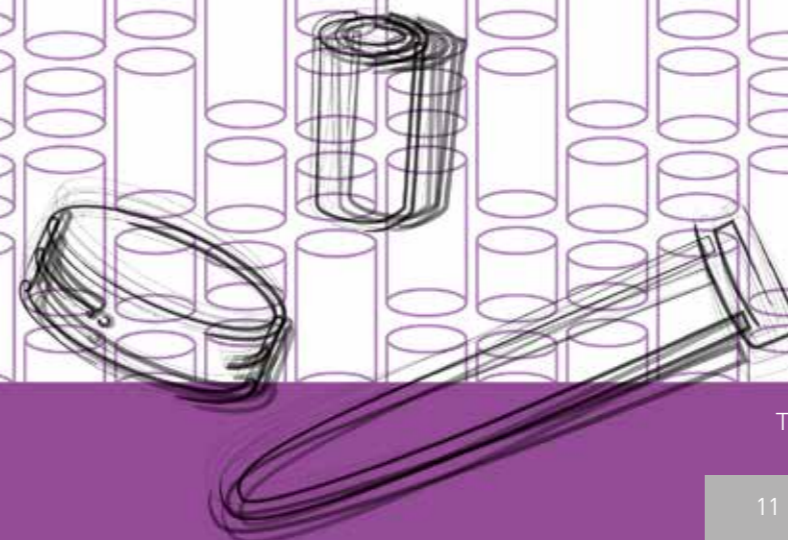

The images provided in this catalogue are purely indicative

# SPECIFIC PHEROMONES AND ATTRACTANTS

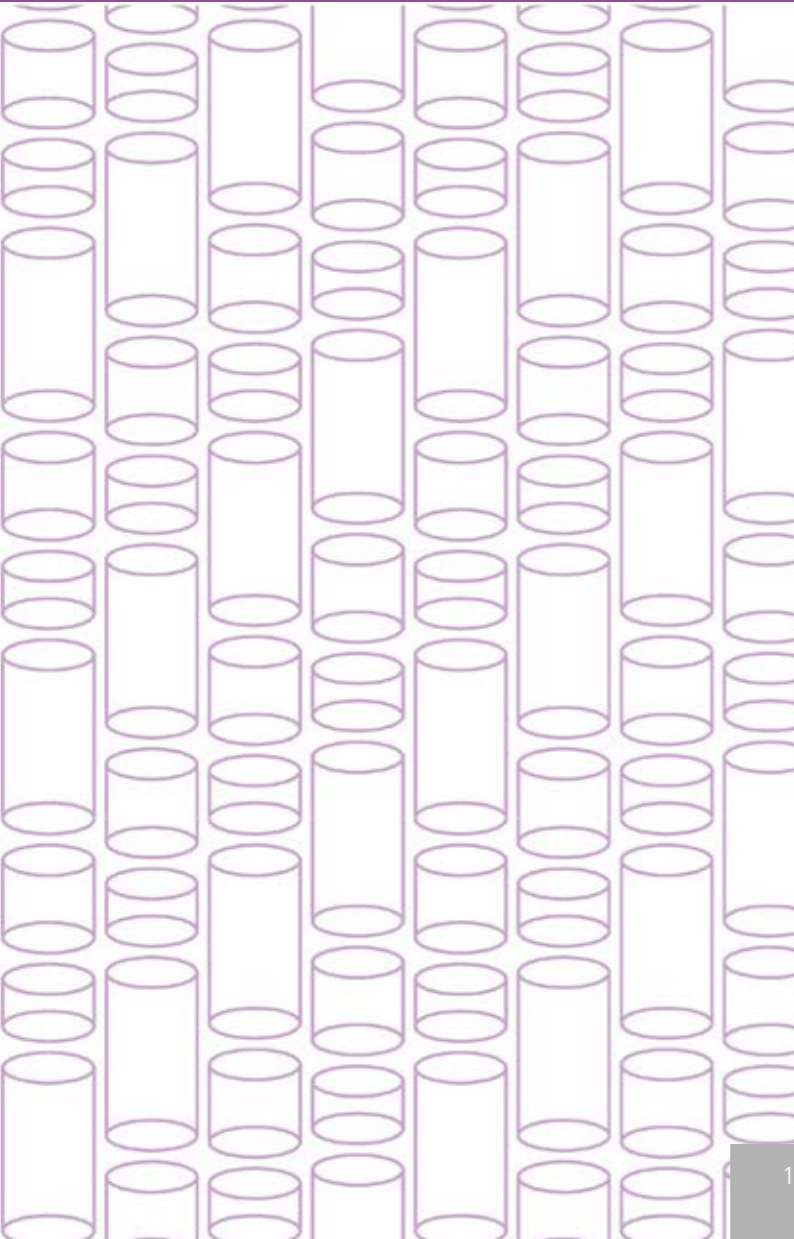

## Phero-Si inPEST

After years of research and innovation, the GEA R&D Team has achieved its goal of **optimizing** and **improving** silicone pheromone supports. The team's efforts led to the replacement of the previous device with a more **innovative** version: the new **"Phero-Si"** pheromone dispenser in PEST, made with ad-hoc silicone blend.

The new dispenser has a characteristic **cylindrical** shape, more **easy-to-handle**, with **more weight** and a **larger emission surface**.

The choice of the new silicone mould also made it possible to:

- **use a mixture more suitable for use in the food industry,**
- **improve the emission of pheromones with which the devices are loaded,**
- **increase effectiveness in the field, promptly detecting even the low presence of pests and returning a higher number of target catches,**
- **guarantee a better pheromone emission over time compared to para dispensers,**
- **create a fully metal detectable version of the device, "Phero-Si MD"**

**in PEST, by adding ferrite to the silicone blend. This technical aspect is increasingly important in food companies and required by the main certification standards (BRC, IFS, etc.).**

## Pheromones and specific attractants

**inPEST pheromone line** exploits the ability of insects to perceive specific semiochemical molecules (pheromones) to alter their behavior.

Due to reduction of insecticides and active substances on the market it is vital to find new techniques to face an ever demanding regulation, with the use of **integrated pest management (IPM)** in all its forms.

With this in mind, inPEST pheromone line gives the possibility of monitoring a large quantity of species reducing the environmental impact to the minimum. In inPEST pheromone line it is also possible to find pheromone dispensers for Mating Disruption Technique to face insects infestations by preventing their reproduction.

Some of the products in this section (Phero-Si silicone supports for pheromones) are available in the **metal detector version Phero-Si MD**.

The attractants in this section can contain allergens.  
For any enquiry please contact our Quality and Regulatory office or our sales team.

### Precautions of use:

To avoid altering the efficacy of the dispensers it is suggested to handle the products with gloves.

### Attention:

All the vials in this section must be used closed (as shown in the picture), for a better functioning.



**PHERO-SI FOOD / PHERO-SI MD FOOD**

*Plodia interpunctella, Ephestia kuehniella*



Sex pheromone.  
Available metal detectable version.

CODE	PACK	CARTON
P-01048	1 pc	SALES UNIT
P-01048D	STRIPS OF 3 PCS	15 pcs

TARGET PEST:



*Plodia interpunctella*



*Ephestia kuehniella*



*Nemapogon (Tinea) granellus*

SUGGESTED TRAPS:



TRAPTEST  
P-250010NE



POLITRAP  
P-04024



MASS® TRAP  
P-25003



MULTITRAP  
P-04042



EASY TRAP  
P-04078

**PHERO-SI / PHERO-SI MD**

*Tinea granella*



Sex pheromone.  
Available metal detectable version.

CODE	PACK	CARTON
P-01003	1 pc	SALES UNIT
P-01003D	STRIPS OF 3 PCS	15 pcs

**PHERO-SI V CLOTHES**

*Tineola bisselliella, Tinea pellionella*



Sex pheromone.  
Vial to be used closed.

CODE	PACK	CARTON
P-01025	1 pc	SALES UNIT
	STRIPS OF 3 PCS	15 pcs



*Tineola bisselliella*



*Tinea pellionella*

**PHERO-SI V / PHERO-SI MD**

*Lasioderma serricornes*



Sex pheromone.  
Vial to be used closed.  
Available metal detectable version.

CODE	PACK	CARTON
P-01002F	1 pc	SALES UNIT
P-01002D	STRIPS OF 3 PCS	15 pcs



*Lasioderma serricornes*



ANOBIDI TRAP  
P-04017



STORE TRAP  
P-04028

**PHERO-SI / PHERO-SI MD**

*Tribolium spp.*



Aggregation pheromone.  
Available metal detectable version.

CODE	PACK	CARTON
P-01007P	1 pc	SALES UNIT
P-01007D	STRIPS OF 3 PCS	15 pcs

TARGET PEST:



*Tribolium spp.*

**PHERO-SI / PHERO-SI MD**

*Sitophilus granarius*



Aggregation pheromone.  
Available metal detectable version.

CODE	PACK	CARTON
P-01005	1 pc	SALES UNIT
P-01005D	STRIPS OF 3 PCS	15 pcs



*Sitophilus granarius*

**PHERO-SI / PHERO-SI MD**

*Sitophilus oryzae*



Aggregation pheromone.  
Available metal detectable version.

CODE	PACK	CARTON
P-01018	1 pc	SALES UNIT
P-01018D	STRIPS OF 3 PCS	15 pcs



*Sitophilus oryzae*

**PHERO-SI / PHERO-SI MD**

*Trogoderma granarium, T. inclusum, T. variabile, T. glabrum*



Sex pheromone.  
Available metal detectable version.

CODE	PACK	CARTON
P-01008	1 pc	SALES UNIT
P-01008D	STRIPS OF 3 PCS	15 pcs



*Trogoderma granarium*

SUGGESTED TRAPS:



3 WAY TRAP  
P-04031

**PHERO-SI / PHERO-SI MD**

*Rhyzopertha dominica*



Aggregation pheromone.  
Available metal detectable version.

CODE	PACK	CARTON
P-01020	1 pc	SALES UNIT
P-01020D	STRIPS OF 3 PCS	15 pcs

TARGET PEST:



*Rhyzopertha dominica*

SUGGESTED TRAPS:



3 WAY TRAP  
P-04031

**PHERO-SI / PHERO-SI MD**

*Prostephanus truncatus*



Aggregation pheromone.  
Available metal detectable version.

CODE	PACK	CARTON
P-01078	1 pc	SALES UNIT
P-01078D	STRIPS OF 3 PCS	15 pcs



*Prostephanus truncatus*



3 WAY TRAP  
P-04031



EASY TRAP  
P-04078



MULTI TRAP  
P-04042

**ROACH TAB**



Ø12 mm

Food based attractant  
840mg/tablet



CODE	PACK	CARTON
P-01052	10 pcs BLISTER	SALES UNIT 200 pcs



*Blatta*



GEOTRAP GEL  
P-04047

**PHERO-SI / PHERO-SI MD COMBINED**

Food moths, anobiidi



Sex pheromone.  
Available metal detectable version.

CODE	PACK	CARTON
P-01051	1 pc	SALES UNIT
P-01051D	STRIPS OF 3 PCS	15 pcs

TARGET PEST:



*Plodia interpunctella*



*Ephestia kuehniella*



*Lasioderma serricorne*

SUGGESTED TRAPS:



ANOBIIDI TRAP  
P-04017



MULTI TRAP  
P-04042



STORE TRAP  
P-04028



EASY TRAP  
P-04078

**PHERO-SI / PHERO-SI MD MULTISPECIES**



Aggregation pheromone.  
Sex pheromone.  
Available metal detectable version.

CODICE ART.	PACK	CARTON
P-01058	1 pc	SALES UNIT
P-01058D	STRIPS OF 3 PCS	15 pcs

TARGET PEST:



*Tribolium spp.*



*Lasioderma serricorne*



*Sitophilus granarius*



*Sitophilus oryzae*



*Sitophilus zeamais*

SUGGESTED TRAPS:



3 WAY TRAP  
P-04031

MULTISPECIES TAB



Combine with specific pheromones.

CODE	PACK	CARTON
P-01154	1 pc STRIPS OF 3 PCS	SALES UNIT 15 pcs

TARGET PEST:

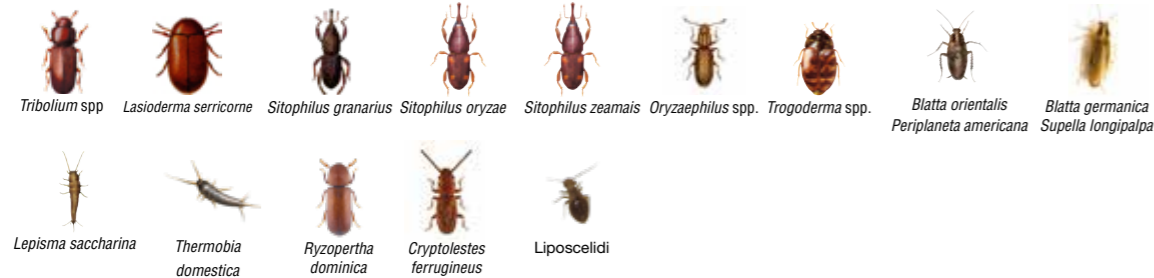

SUGGESTED TRAPS:



3 WAY TRAP  
P-04031

TARGET PEST:



*Dermestes spp.*

SUGGESTED TRAPS:



3 WAY TRAP  
P-04031



3 WAY PHERO PACK  
P-04031PP



ATTRACTANT FOR SILVERFISH

Attractant in cellulose disc form to be inserted into a trap for monitoring silverfish of the genera Lepismatidae, Thermobia, and Ctenolepisma.

CODE	PACK	CARTON
P-01282	1 pc STRIPS OF 3 PCS	SALES UNIT 15 pcs

FOOD-BASED ATTRACTANT



TARGET PEST:



*Lepismatid*

SUGGESTED TRAPS:

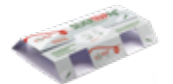

SILVERTRAP Ag<sup>47</sup>  
P-04163



STORE TRAP  
P-04028

DISPENSER – *Popillia japonica* BLISTER

Pair of dispensers in blister pack for use in combination with a trap for monitoring *Popillia japonica* (Japanese beetle)

CODE	PACK	CARTON
P-04125	1 pc	SALES UNIT 10 pcs



TARGET PEST:



*Popillia japonica*

SUGGESTED TRAPS:



MASS® TRAP  
P-25003

DERMESTES TAB



Protein attractant for *Dermestes* spp. to be introduced inside a glue trap for crawling insects for the monitoring of *Dermestes* spp.

CODE	PACK	CARTON
P-01267	1 pc STRIPS OF 3 PCS	SALES UNIT 15 pcs

Measures:  
- Height: 9 mm  
- Length: 14 mm  
- Width: 14 mm  
- Weight: 2,5 g/tablet

**PIOPHILACYL**

ATTRACTANT for *Piophilidae casei*



Attractant dispenser to be inserted inside a trap for monitoring the presence of *Piophilidae casei*.

The PP cylinder must be used open.

CODE	PACK	CARTON
P-01272	2 pcs	SALES UNIT 6 pcs

**Trap size:**

- Height: 50 mm
- Internal diameter: 13 mm
- External diameter: 15 mm
- Internal volume max: 5 ml

**TARGET PEST:**



*Piophilidae casei*

**SUGGESTED TRAPS:**



**ECOTRAP MAXI**  
WHITE: P-02004G40B



**TUNNEL QUADRO MINI**  
P-02047



**TUNNEL MAXI**  
P-02020



**BOOK REFIL**  
P-02019



**ECOTRAP QUADRO MINI**  
P-02013B



# Mating disruption technique

The method consists of saturating the environment with overdoses of the sex pheromone that is normally emitted by the female of each specific targeted insect, to an extent that prevents the male from locating and fertilising the female.

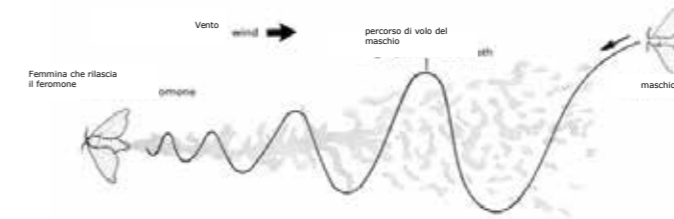

## Objective:

Ridurre il numero degli accoppiamenti della popolazione infestante

## How?

By spreading a high quantity of synthetic pheromone, using high-dose dispensers. This is to interfere with the perception and response of the male to the sex pheromone emitted by the female according to the following mechanisms:

- THE MALES ARE UNABLE TO LOCATE THE FEMALE WHOSE NATURAL CALL IS "MASKED"
- HABITUATION OF THE NERVOUS SYSTEM
- THE MALE'S SENSORY RECEPTORS ARE SATURATED

## ADVANTAGES

- HIGHLY SPECIFIC AGAINST TARGETED INSECTS
- SAFE FOR USERS
- NO INTERFERENCE WITH OTHER BIOLOGICAL CONTROLS
- NO DAMAGE TO THE ENVIRONMENT

# TWIST - TIE MD<sup>2</sup> inPEST®

## COMPOSITION:

BLUE OR GREY SILICONE AND FERRITE

## SEX PHEROMONE:

(9Z,12E)-TETRADECA-9,12-DIEN-1-YL ACETATE (CAS: 30507-70-1)

## REGISTERED PRODUCT:

**BIOCIDE PRODUCT**

AUTHORIZATION NO.: FR-2020-0028



## TARGETED INSECTS:

*Plodia interpunctella* e *Epehstia kuehniella*

## ADDITIONAL TARGETED INSECTS:

*Epehstia elutella*, *Cadra cautella*,  
*Cadra calidella* e *Cadra figulilella*

## WHERE TO USE IT?

FOOD INDUSTRY, PRODUCTION AND STORAGE.

## HOW TO USE?

2 m of Twist-Tie MD2 inPEST® covers 600 m<sup>3</sup>.  
It can be directly installed on installations or structural elements, such as electrical conduits, shelves, pillars, by marking it with its warning sign. (vd pag.26).

TARGET PEST:



*Plodia interpunctella*



*Epehstia kuehniella*



NEW PACKAGING  
ENVELOPE WITH HERMETIC  
ZIP CLOSURE

**STRENGTHS:** String sold in 2 m skeins for greater ease of use during installation and replacement.  
EACH 2 m SKEIN covers a volume of 600 m<sup>3</sup>.

## ADVANTAGES:

Compared to other dispensers available on the market, it is a fully metal detectable instrument as ferrite, which gives it this property, is included in the holder.  
Detectability is a key requirement for BRC and IFS food safety standards.

Furthermore, once the total amount of linear metres of Twist Tie MD<sup>2</sup> to be used has been established based on the volumes to be treated (2 m of Twist-Tie MD<sup>2</sup> inPEST® saturates 600 m<sup>3</sup>), its special format ( Tie ) allows it to be portioned, by simple cutting. In this way, portions of the string can be distributed evenly throughout the room or concentrated around critical machinery or installations.

Another advantage of the Twist-Tie MD2 is its greater visibility compared to an ordinary dispenser, a feature that is not secondary in terms of the efficiency of the service provided to replace it once it is no longer operational.



## Twist Tie MD<sup>2</sup> inPEST<sup>®</sup> Grey

grey metal detectable mating disruption twist tie  
*Plodia interpunctella*, *Ephestia kuehniella*

Sex pheromone.  
REGISTERED PRODUCT  
Detectable version.

TARGET PEST:



*Plodia interpunctella*



*Ephestia kuehniella*



CODE	PACK	CARTON
P-01156	5 pcs 2 meters each	SALES UNIT 10 mt

## Twist Tie MD<sup>2</sup> inPEST<sup>®</sup> Blue

blue metal detectable mating disruption twist tie  
*Plodia interpunctella*, *Ephestia kuehniella*

Sex pheromone.  
REGISTERED PRODUCT  
Detectable version.



CODE	PACK	CARTON
P-01162	5 pcs 2 meters each	SALES UNIT 10 mt

### DEVICES FOR TESTING THE EFFICACY OF THE MATING DISRUPTION



EASY TRAP  
P-04078



PHERO-SI OVERLOADED  
P-01157



BIOTEST MD<sup>2</sup>  
P-01158



CHECK POINT MD<sup>2</sup>  
70x70 mm  
P-14112TC  
HIPS sign indicating the use of the mating disruption technique.

## FOOD INDUSTRY CRAWLING INSECTS

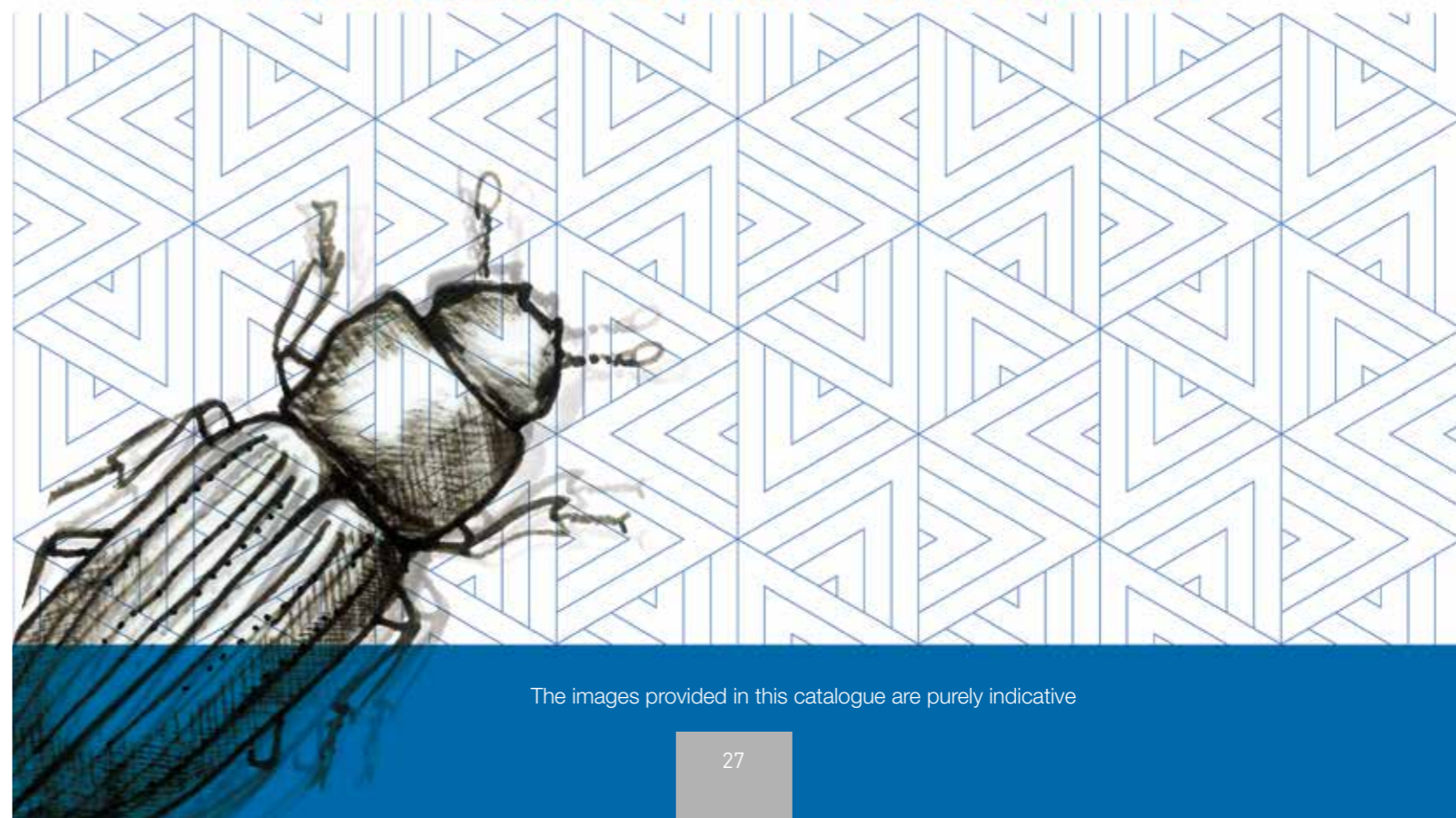

The images provided in this catalogue are purely indicative

# FOOD INDUSTRY CRAWLING INSECTS

## 3 Way Line Necrobia Line

Monitoring pests with specific traps lets obtain immediate feedback on the appearance of an infestation.

**inPEST** has designed a trap specifically for monitoring food industry beetles. This trap's shape grants access to insects, which are usually hard to catch, thanks to an innovative food based tablet integrating it with a multi-species pheromone dispenser.

### Good reasons to choose our "3way line":

- Easy to use: Just insert the cardboard trap in the plastic base and close with a simple "click"; the innovative, reusable cover protects the trap from dust and damp, guaranteeing efficacy of the adhesive surface for over a month.
- Easy to remove, it's impossible to get dirty!
- "Dust-proof" glue: the top and bottom adhesive surface of the cardboard trap is spread in parallel stripes in order to increase dust resistance.

### STORAGE CONDITIONS OF GLUE TRAPS:

Stored in a cool and dry place (lower than 25°C / 77°F and 55% R.H.) in their original packaging.

Products are guaranteed to perform correctly up to 3 years.

## 3 Way Line

3 WAY TRAP  
3 WAY TRAP PHERO PACK  
MAGNETIC TRAP  
MAGNETIC TRAP DETECTABLE  
FLASH OIL Phero Pack  
FLASH OIL MAGNETIC TRAP  
FLASH OIL MAGNETIC TRAP DETECTABLE  
REFILL OIL BOTTLE  
REFILL FLASH PAPER  
WIRE 25  
WIRE 59  
PROTECTION CAGE

## Necrobia Line

RUFY TRAP  
RUFY TRAP WATERPROOF

# 3 WAY TRAP

TRAP FOR MONITORING CRAWLING INSECTS

TARGET PEST:



**Cardboard glue trap with dust-proof glue.** The peculiar way the glue is spread on the trap also increases the available glue surface.

**MUST BE ACTIVATED WITH SPECIFIC PHEROMONES AND/OR WITH FOOD TABLET.**  
See section "FEROMONES AND SPECIFIC ATTRACTANTS" p.10

CODE	PACK	OUTER CARTON
P-04031	2 pcs	SALES UNIT 28 pcs

IDEAL FOR:

MAGNETIC TRAP  
P-04131MAG



MAGNETIC TRAP DETECTABLE  
P-04131MAGF



WAVE-SPREAD GLUE



FLOWPACK  
2 PIECES

# 3 WAY TRAP PHERO PACK

TRAP FOR MONITORING CRAWLING INSECTS

TARGET PEST:

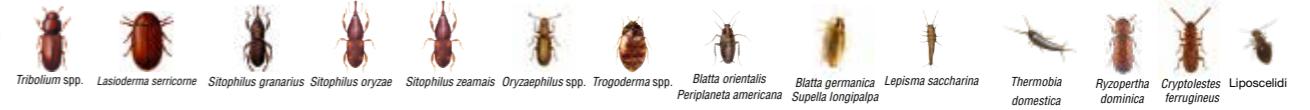

**PRE-ACTIVATED WITH MULTI-SPECIES PHEROMONE AND FOOD TABLET.**

CODE	PACK	OUTER CARTON
P-04031PP	2 pcs	SALES UNIT 20 pcs

3 WAY TRAP P-04031 + MULTISPECIES TAB P-01154 + PHERO-SI MULTISPECIES P-01058



FLOWPACK  
ALUMINUM  
2 PIECES

IDEAL FOR:

MAGNETIC TRAP  
P-04131MAG



MAGNETIC TRAP DETECTABLE  
P-04131MAGF



PHERO-SI  
MULTISPECIES  
P-01058



3 WAY TRAP  
P-04031



MULTISPECIES TAB  
P-01154



# MAGNETIC TRAP

# MAGNETIC TRAP DETECTABLE

Polypropylene plastic shell closed with the use of extra strong magnets. Glue/pitfall trap sold separately. (see pages 27).

**New version** with additional edges to protect the inner trap from dust, and 2 slots at the base and 1 on the cover that allow and facilitate anchoring using the fixing wire (sold separately).

CODE	PACK	OUTER CARTON
P-04131MAG	-	SALES UNIT <b>10</b> pcs

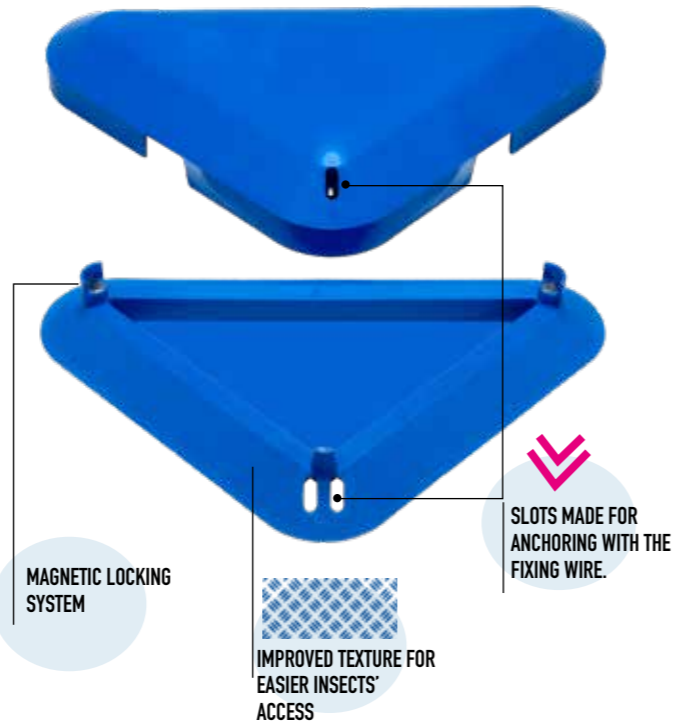
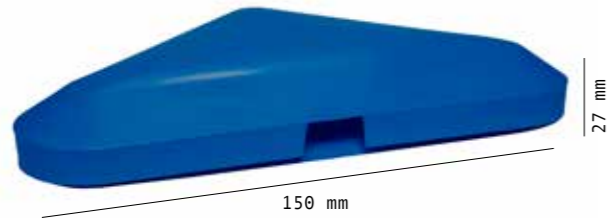

Polypropylene plastic shell **metal detectable** closed with the use of extra strong magnets. Glue/pitfall trap sold separately (see pages 27).

**New version** with additional edges to protect the inner trap from dust, and 2 slots at the base and 1 on the cover that allow and facilitate anchoring using the fixing wire (sold separately).

CODE	PACK	OUTER CARTON
P-04131MAGF	-	SALES UNIT <b>10</b> pcs

**MD - METAL DETECTABLE**



IDEAL FOR



MAGNETIC TRAP +  
3 WAY PHERO PACK

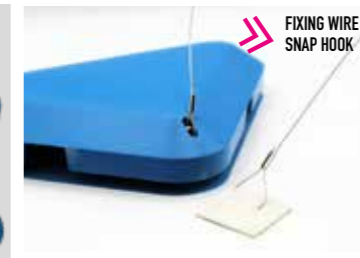
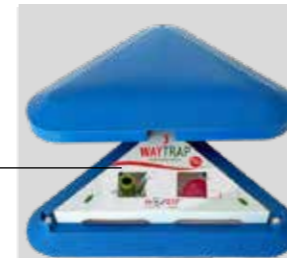

The super speedy monitoring  
for the **trained professional**

» **FLASH OIL** »  
DEVICE FOR MONITORING CRAWLING INSECTS IN STORAGE

It is a PRACTICAL device

- ✓ **READY TO USE**
- ✓ **QUICK INSTALLATION**
- ✓ **BEST SOLUTION FOR DUSTY ENVIRONMENTS**
- ✓ **WIDE ATTRACTION SPECTRUM**
- ✓ **Allergen-free mineral oil**  
(which can be used in the food industry)
- ✓ **MULTISPECIES**  
(one device detects multiple foodstuffs pests)

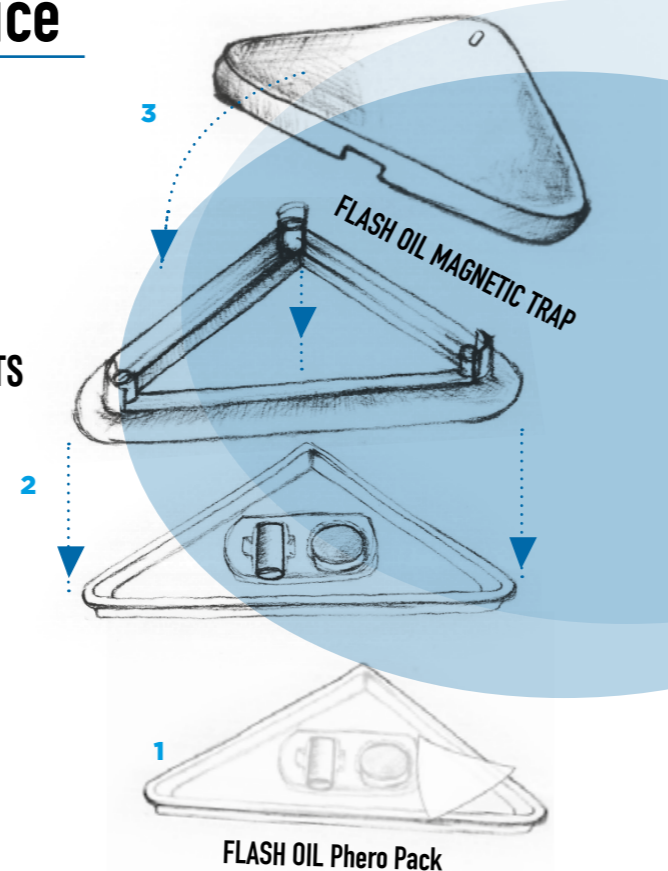

**FLASH OIL Phero Pack**

MONITORING DEVICE FOR CRAWLING INSECTS IN THE FOOD INDUSTRY



**Triangular tray in PET with 2 attractants included**  
Triangular tray in PET with 2 attractants include (multi-species pheromone and multi-species tablet, refill flash paper with oil).  
**Ready to use**

CODE	PACK	OUTER CARTON
P-04331PP	-	SALES UNIT <b>10</b> pcs

**PRE BAITED**

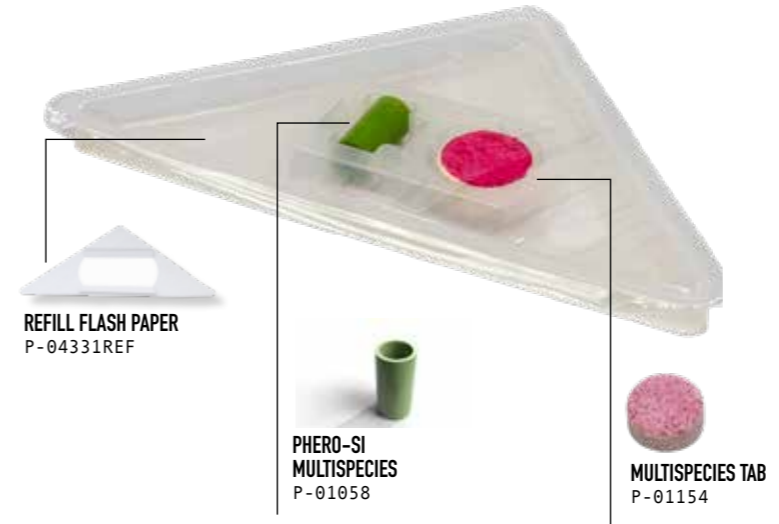

**IDEAL FOR:**

**FLASH OIL MAGNETIC TRAP**  
P-04331MAG



**FLASH OIL MAGNETIC TRAP  
DETECTABLE**  
P-04331MAGF



## FLASH OIL MAGNETIC TRAP

Polypropylene plastic shell, closed with the use of extra strong magnets.

CODE	PACK	OUTER CARTON
P-04331MAG	1pc	SALES UNIT 10 pcs

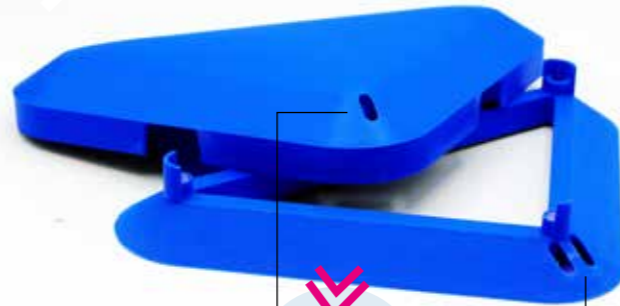

SLOTS MADE FOR ANCHORING WITH THE FIXING WIRE.

## FLASH OIL MAGNETIC TRAP Detectable

Metal detectable polypropylene plastic shell, closed with the use of extra strong magnets.

CODE	PACK	OUTER CARTON
P-04331MAGF	1pc	SALES UNIT 10 pcs



MD - METAL DETECTABLE

IDEAL FOR



## THE inPEST SOLUTION

Flash Oil Phero Pack + Flash Oil Magnetic Trap: advanced monitoring for the food industry.

### FLASH OIL Phero Pack

P-04331PP  
Triangular PET tray with attractant and multi-species pheromone included. It is a detection system designed to monitor the presence of crawling insects quickly and effectively.



FLASH OIL MAGNETIC TRAP  
P-04331MAG  
Polypropylene shell with magnetic closure and slots for easy anchoring. For optimal protection in dusty or humid environments.



+



Integrated attractant system specifically designed for monitoring multiple pest species.

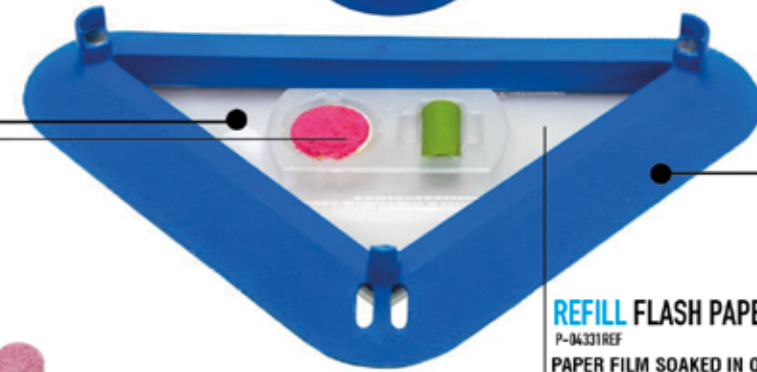

### REFILL FLASH PAPER

P-04331REF  
PAPER FILM SOAKED IN OIL prevents captured insects from escaping and ensures more reliable monitoring.

## REFILL OIL BOTTLE

✓ 250 ml bottle for refilling the **FLASH OIL Phero Pack** (P-04331PP).



250 ml

CODE	PACK	OUTER CARTON
P-04133	-	SALES UNIT 5 pcs

## REFILL FLASH PAPER

CODE	PACK	OUTER CARTON
P-04331REF	-	SALES UNIT 100 pcs

**NEW**  
WINGS THAT FACILITATE  
REPLACEMENT



## WIRE 25



## WIRE 59



Fixing cable. Length 25cm.

CODE	PACK	OUTER CARTON
P-03081	-	SALES UNIT 10 pcs

Fixing cable with carabiner. Length 59 cm.

CODE	PACK	OUTER CARTON
P-03075	-	SALES UNIT 10 pcs

## PROTECTION CAGE

**Fixing and protection device for Magnetic Trap.**

A sort of triangular plastic frame, which can be fixed to the ground with screws and cages the Magnetic Trap by using three clip fasteners.

CODE	PACK	OUTER CARTON
P-04331MAGPRO	-	SALES UNIT 10 pcs



IDEAL FOR:

**MAGNETIC TRAP**  
P-04131MAG



**MAGNETIC TRAP DETECTABLE**  
P-04131MAGF



**FLASH OIL MAGNETIC TRAP**  
P-04331MAG



**FLASH OIL MAGNETIC TRAP  
DETECTABLE**  
P-04331MAGF

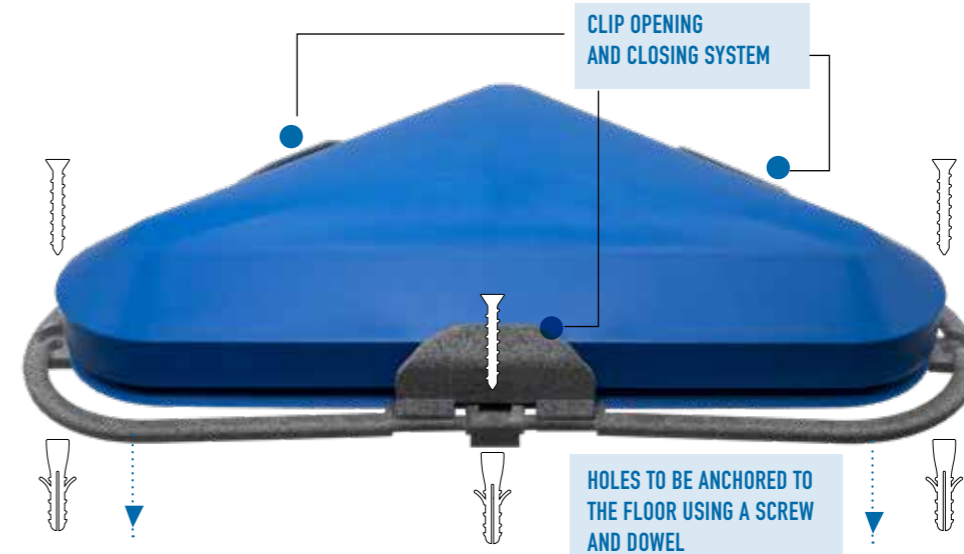

## RUFY TRAP

**Device ready to use** for monitoring of *Necrobia rufipes*. Consisting of a cardboard box with **4 entrances and a transparent plastic window** to facilitate inspection. Inside there is a **white plastic adhesive tray and two attractants**.

CODE	CARTON	OUTER PACK
P-04259	-	SALES UNIT 20 pcs



READY TO USE

NEW FORMULATION

ENVIRONMENTAL AND FOOD

## RUFY TRAP WATERPROOF

**Ready-to-use and water-resistant device** for monitoring *Necrobia rufipes* consisting of a white plastic glued base and a black plastic tunnel. Inside there are two attractants.

CODE	CARTON	OUTER PACK
P-04259WP	-	UNITÀ DI VENDITA 20 pz

WATERPROOF



READY TO USE

NEW FORMULATION

ENVIRONMENTAL AND FOOD



## FOOD INDUSTRY FLYING INSECTS



The images provided in this catalogue are purely indicative

# FOOD INDUSTRY FLYING INSECTS

## **inPEST's food industry flying insects monitoring line**

counts the largest number of glue traps and pit fall traps on the market.

Adhesives and materials used are specifically studied to give optimal results even in "extreme" situations such as dusty environments, damp environments or outdoors.

In combination with pheromone dispensers of the inPEST pheromone line, it is easy to check the presence of target insects in the monitored areas.

### **TARGET PEST:**

*Ephestia kuehniella, Plodia interpunctella, Lasioderma serricorne, Nemapogon granella, Tineola bisselliella, Tinea pellionella.*

### **STORAGE CONDITIONS OF GLUE TRAPS:**

Stored in a cool and dry place (lower than 25°C / 77°F and 55% R.H.) in their original packaging.

Products are guaranteed to perform correctly up to 3 years.

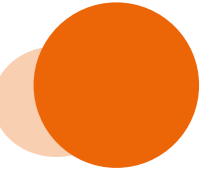

xTRAP DELTA  
EASY TRAP  
EASY TRAP PHERO PACK  
MULTITRAP  
STORETRAP  
ANOBIIDI TRAP  
GEO PAD FOOD GREEN  
GEO PAD CLOTHES BLUE  
MOTH HANGER  
TRAPTEST  
MASS® TRAP  
POLITRAP  
POLITRAP GB

## xTRAP DELTA

xTrap It is a monitoring device that can be activated with pheromones and attractants and is capable of detecting target insect captures via an integrated camera.

The data is available on the xFarm platform to monitor population trends and support timely and targeted control measures. xTrap Delta allows you to monitor remote areas of production facilities and critical points that are difficult to reach. Ideal for mechanized warehouses where pest control operators do not have access.

Pheromones to be purchased separately

**NEW**



TARGET PEST:



*Plodia interpunctella*



*Ephestia kuehniella*



*Lasioderma serricorne*

CODE
P-04164



## EASY TRAP

TARGET PEST:



*Plodia interpunctella*



*Ephestia kuehniella*



*Nemapogon (Tinea) granellus*



*Tineola bisselliella*



*Tinea pellionella*

Cardboard trap, detectable by metal detectors.

**MUST BE ACTIVATED WITH SPECIFIC PHEROMONES**  
Pheromones sold separately

CODE	PACK	OUTER CARTON
P-04078	5 pcs	SALES UNIT 60 pcs
<b>GLUE AREA</b>	2 areas 120x150 mm	



**DUST PROOF GLUE**

## EASY TRAP PHERO PACK

*Ephestia kuehniella* e *Plodia interpunctella*.

TARGET PEST:



*Plodia interpunctella*



*Ephestia kuehniella*

Cardboard glue trap with "dust-proof" glue.

Ready to use, packed in barrier film. **PRE-ACTIVATED WITH SPECIFIC PHEROMONES - METAL DETECTABLE**

CODE	PACK	OUTER CARTON
P-04078PP	3 PCS EASY TRAP P-04078 CON 3 PCS PHEROMONES P-01048D	SALES UNIT 30 pcs
<b>GLUE AREA</b>	2 areas 120x150 mm	



TARGET PEST:



*Plodia interpunctella*



*Ephestia kuehniella*



*Lasioderma serricorne*



*Tineola bisselliella*



*Tinea pellionella*

## MULTITRAP

CARDBOARD TRAP

✓ MUST BE ACTIVATED WITH SPECIFIC PHEROMONES.  
Pheromones sold separately

CODE	PACK	OUTER CARTON
P-04042	-	SALES UNIT 60 pcs
<b>GLUE AREA</b>	285 x 160 mm	



## STORE TRAP

CARDBOARD TRAP

✓ MUST BE ACTIVATED WITH SPECIFIC PHEROMONES.  
Pheromones sold separately

CODE	PACK	OUTER CARTON
P-04028	-	SALES UNIT 60 pcs
<b>GLUE AREA</b>	70 x 325 mm	



## ANOBIIDI TRAP

CARDBOARD TRAP

TARGET PEST:



*Lasioderma serricorne*

✓ MUST BE ACTIVATED WITH SPECIFIC PHEROMONES.  
Pheromones sold separately

CODE	PACK	OUTER CARTON
P-04017	-	SALES UNIT 60 pcs
<b>GLUE AREA</b>	90 x 150 mm	



pre-activated adhesive trap with pheromone and special container

## GEO PAD FOOD GREEN

CARDBOARD GLUE TRAP

✓ PRE- ACTIVATED WITH SPECIFIC PHEROMONES FOR FOOD MOTHS.

CODE	PACK	OUTER CARTON
P-04077	10 pcs	SALES UNIT 100 pcs

GLUE AREA 115 x 50 mm

TARGET PEST:



## GEO PAD CLOTHES BLUE

CARDBOARD GLUE TRAP

✓ PRE- ACTIVATED WITH SPECIFIC PHEROMONES FOR FOOD MOTHS.

CODE	PACK	OUTER CARTON
P-04091	10 pcs	SALES UNIT 100 pcs

GLUE AREA 115 x 50 mm

TARGET PEST:



## MOTH HANGER

Transparent PE plastic container for GEO PAD CLOTHES BLUE and GEO PAD FOOD GREEN.

CODE	PACK	OUTER CARTON
P-04100	10 pcs	SALES UNIT 10 pcs



## TRAPTEST

✓ MUST BE ACTIVATED WITH SPECIFIC PHEROMONES.  
Pheromones sold separately

CODE	PACK
P-25001ONE	SALES UNIT 1 pcs lid + 3 pcs glue base

## GLUE BASE

CODE	PACK
P-25001REF	SALES UNIT 9 pcs glue base

TARGET PEST:



NEW STRONGER RINGS

WATERPROOF

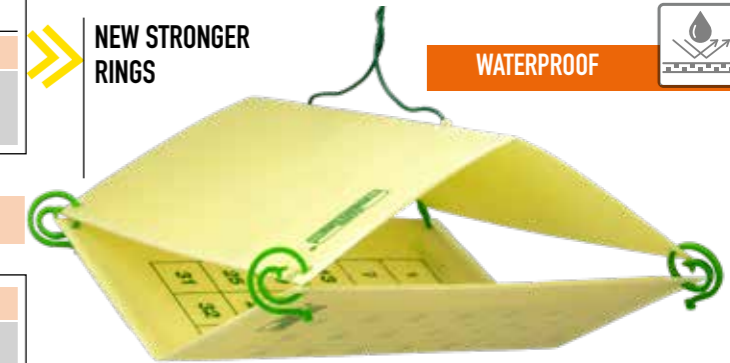

## MASS® TRAP

Funnel trap with collector plastic bag. Particularl suitable for food industry moths in dusty environments such as mills.

✓ MUST BE ACTIVATED WITH SPECIFIC PHEROMONES.  
Pheromones sold separately

CODE	PACK
P-25003	SALES UNIT 10 pcs (includes 30 bags)

TARGET PEST:

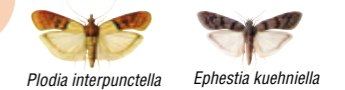

## POLITRAP

Pitfall trap ideal for use with water or glue board (P-04024GLUESO).

✓ **MUST BE ACTIVATED WITH SPECIFIC PHEROMONES.**  
Pheromones sold separately

CODE	PACK	OUTER CARTON
P-04024	-	SALES UNIT 10 pcs



## POLITRAP GB

Da posizionare all'interno della **POLITRAP**.

CODE	PACK	OUTER CARTON
P-04024GLUESO	-	SALES UNIT 10 pcs



## METAL-DETECTABLE PRODUCTS

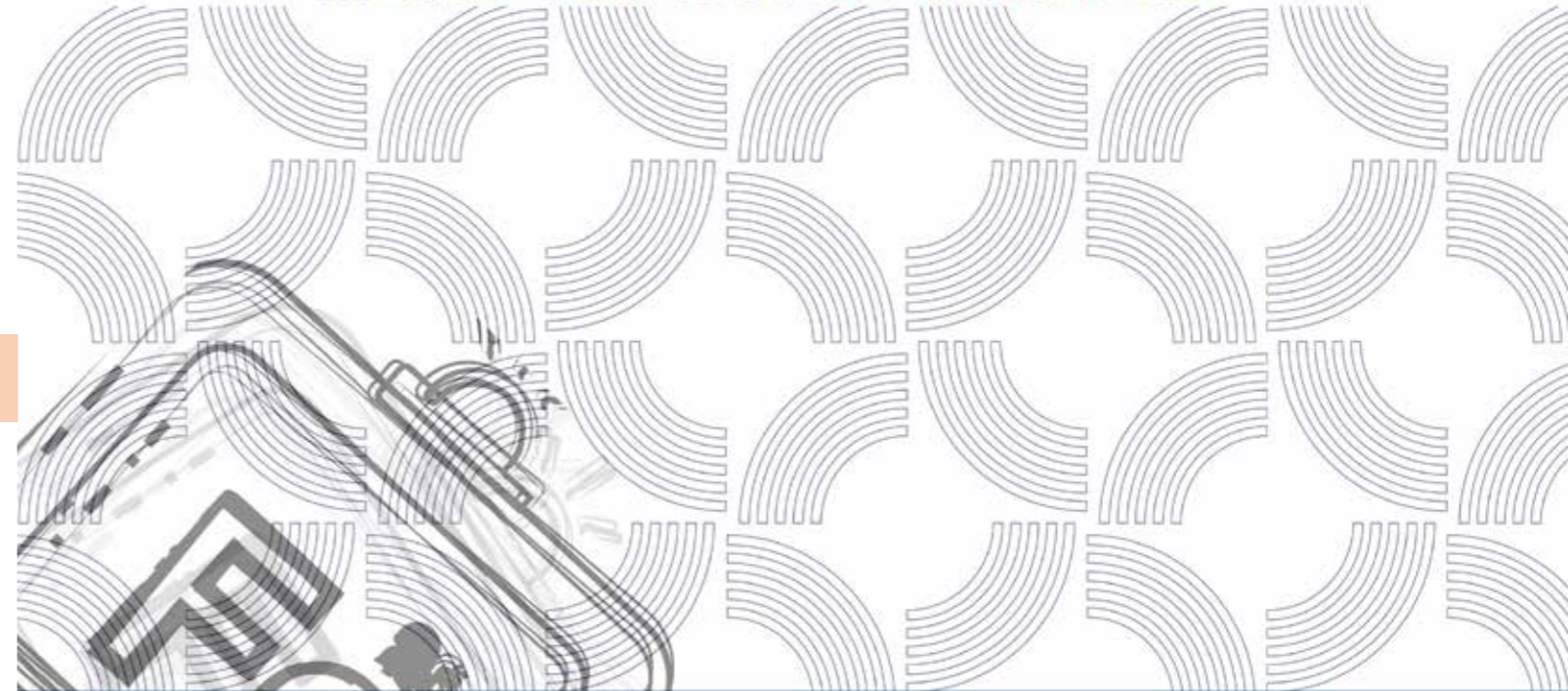

The images provided in this catalogue are purely indicative

# METAL-DETECTABLE PRODUCTS

## Dedicated line to the real IPM professionals

inPEST strives every day to offer its customers quality products that are ideal tools to allow PCO / Trained Professional to carry out effective interventions, respectful of both environment and current regulations. The ideal customer for this product line have professionalism and competence for an advanced IPM

## A line entirely detectable by metal detector.

The customer will find in these pages the most complete line of detectable by metal detector inPEST products for the Pest Control market. The Detectable Products Line is indeed, together with the Pheromones Line, the spearhead of inPEST. It is the result of years of Research & Development on products, innovation and experience in the market of professional devices for pest monitoring.

## All the advantages of ferrite.

Ferrite-enriched inPEST products offer PCO / Trained Professional enormous advantages during interventions, with a modestly higher cost than non-detectable products. The traceability and product's positioning control are great key elements during interventions and an inPEST product detectable by the metal detector guarantees easy traceability and positioning control. All thanks to ferrite. inPEST products have been made in such a way as to be detectable to the metal detector even only in really tiny part (if, for example, the product splinters) allowing to easily identify its position even if it is not intact. The use of this kind of products is strongly suggested, for example, in the food industries and in all those environments where is essential absolute control over the positioning of the products used for the intervention.

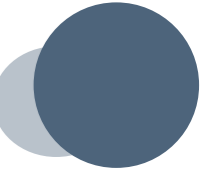

## PHERO-SI MD

Twist Tie MD<sup>2</sup> inPEST Grey

Twist Tie MD<sup>2</sup> inPEST Blue

MAGNETIC TRAP DETECTABLE

FLASH OIL MAGNETIC TRAP DETECTABLE

EASY TRAP

EASY TRAP PHERO PACK

CABLE TIE MD

DETECTABLE PEN

CERABILE

DETECTABLE PRODUCTS LINE:  
monitoring with safety

## PHERO - SI MD

Gray support in silicone and ferrite, **fully detectable by metal detector.**

CODE	PACK	OUTER CARTON
P-XXXXXD	<b>1 pc</b> (STRIPS OF 3 PCS)	SALES UNIT <b>15 pcs</b>

For the complete list of target insects & supports for pheromones with detectable version see pages 10 - 23.



BIOCIDE PRODUCT  
Authorization N. FR-2020-0028

## Twist Tie MD<sup>2</sup> inPEST® Grey

grey metal detectable mating disruption twist tie  
*Plodia interpunctella*, *Ephestia kuehniella*

Sexual pheromone.  
REGISTERED PRODUCT

CODE	PACK	OUTER CARTON
P-01156	<b>5 pcs</b>	SALES UNIT <b>2 m</b>

TARGET PEST:



*Plodia interpunctella*



*Ephestia kuehniella*



## Twist Tie MD<sup>2</sup> inPEST® Blue

Blue metal detectable mating disruption string  
*Plodia interpunctella*, *Ephestia kuehniella*

Sexual Pheromone  
REGISTERED PRODUCT

CODE	PACK	OUTER CARTON
P-01162	<b>5 pcs</b>	SALES UNIT <b>2 m</b>



DEDICATED SECTION PAG. 20



# MAGNETIC TRAP Detectable

MD - METAL  
DETECTABLE

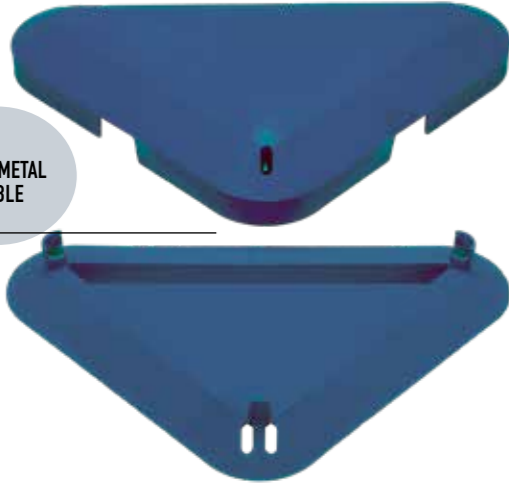

Polypropylene plastic shell metal detectable closed with the use of extra strong magnets. Glue/pitfall trap sold separately (see pages 27).

New version with additional edges to protect the inner trap from dust, and 2 slots at the base and 1 on the cover that allow and facilitate anchoring using the fixing wire (sold separately).

CODE	PACK	OUTER CARTON
P-04131MAGF	-	SALES UNIT 10 pcs

IDEAL FOR:



# FLASH OIL MAGNETIC TRAP Detectable

Metal detectable polypropylene shell

CODE	PACK	OUTER CARTON
P-04331MAGF	1pc	SALES UNIT 10 pcs



MD - METAL  
DETECTABLE

IDEAL FOR:



# EASY TRAP

TARGET PEST:



Cardboard glue trap with "dust-proof" glue.

MUST BE ACTIVATED WITH SPECIFIC PHEROMONES  
METAL DETECTABLE  
Pheromones sold separately

CODE	PACK	OUTER CARTON
P-04078	5 pcs	SALES UNIT 60 pcs

GLUE AREA 2 areas 120x150 mm

DUST PROOF GLUE



# EASY TRAP PHERO PACK

*Ephestia kuehniella* e *Plodia interpunctella*.

TARGET PEST:



Cardboard glue trap with "dust-proof" glue.

Ready to use, packed in barrier film. PRE-ACTIVATED WITH SPECIFIC PHEROMONES - METAL DETECTABLE

CODE	PACK	OUTER CARTON
P-04078PP	3 PCS EASY TRAP P-04078 CON 3 PCS PHEROMONES P-01048D	SALES UNIT 30 pcs

GLUE AREA 2 areas 120x150 mm



## CABLE TIE MD

**Plastic reusable cable ties** detectable to the metal detector. Ideal for securing safety containers and multi-media traps with fixed supports.

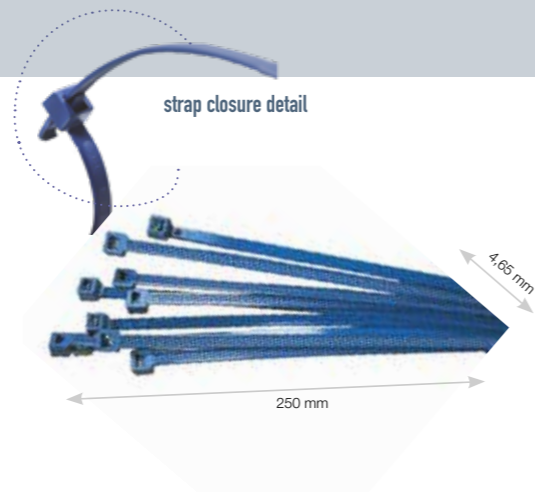

CODE	PACK	OUTER CARTON
P-08033	-	SALES UNIT <b>100</b> pcs

**IDEAL FOR:**

**MULTI CATCH METAL**  
P-03036

**UNIBOX**  
P-03039  
P-03039T

**EASY TRAP**  
P-04078

**EASY TRAP  
PHERO PACK**  
P-04078PP

## DETECTABLE PEN

Retractable detectable pen made to be detected and rejected by typical metal detection machines.

✓ **IDEAL FOR USE IN FOOD FACTORIES.**

CODE	PACK	OUTER CARTON
P-08028	-	SALES UNIT <b>100</b> pcs



## CERABILE

**High visibility (blue) sterile metal detectable plaster.** Thanks to an internal metal strip this plaster is detected by metal detectors.

✓ **SUITABLE FOR USE IN FOOD INDUSTRIES**

CODE	PACK	OUTER CARTON
P-08001	<b>50</b> pcs	SALES UNIT <b>1000</b> pcs (20 packs)

internal metal strip



... and other monitoring devices.

## CRAWLING INSECTS LINE



Le immagini fornite nel presente catalogo sono puramente indicative

# CRAWLING INSECTS

## COCKROACHES, BED BUGS, SILVER FISH

In an **INTEGRATED PEST MANAGEMENT** program, one of the key points is understanding how infestation hotspots are distributed in the environment.

The **inPEST CRAWLING INSECTS LINE** offers a wide range of monitoring products, all made with high-quality materials, from cardboard to honeycomb plastic, which give the traps a longer than average lifespan. The excellent glues and new gel or tablet attractant formulations, combined with correct trap positioning, guarantee a high number of captures.

Translated with DeepL.com (free version)

### Target:

*Blattella germanica*, *Blatta orientalis*, *Supella longipalpa*,  
*Periplaneta americana*, *Cimex lectularius*, *Lepisma saccharina*.

### STORAGE CONDITIONS OF GLUE TRAPS:

Stored in a cool and dry place (lower than 25°C / 77°F and 55% R.H.) in their original packaging.

Products are guaranteed to perform correctly up to 3 years.

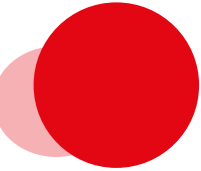

SILVERTRAP Ag<sup>47</sup>  
GEOTRAP  
GEOTRAP EVO  
GEOTRAP MINI  
SCARA4TRAP  
GEOTRAP PLASTIC  
INSECT PAD  
MONITOR GUARD  
EASY BUGS  
BED BUGS TRAP  
BED BUGS TAPE

## SILVERTRAP Ag<sup>47</sup>

Licorice-flavored control device for monitoring silverfish.

- ✓ Adhesive cardboard house with 6 entrances for insects;
- ✓ Licorice-flavored adhesive;
- ✓ Cellulose attractant disc ATTRACTANT FOR SILVERFISH (P-01282)

CODE	PACK	OUTER CARTON
P-04163	20 pcs	SALES UNIT 100 pcs

GLUE AREA 75 x 135 mm



TARGET PEST:



THE ATTRACTIVE DISC SHOULD BE PLACED ON THE ADHESIVE SURFACE.



## GEOTRAP



Pre-activated with attractant gel on the glue surface.

- ✓ aroma licorice

CODE	PACK	OUTER CARTON
P-04047	20 pcs	SALES UNIT 200 pcs

GLUE AREA 90 x 145 mm



## GEOTRAP EVO



Thanks to its peculiar shape it can be positioned on the side still allowing full access to cockroaches.

- ✓ AROMA LICORICE

CODE	PACK	OUTER CARTON
P-04147	20 pcs	SALES UNIT 200 pcs

GLUE AREA 90 x 165 mm



IT CAN BE POSITIONATED ON THE SIDE

## GEOTRAP MINI



Pre-activated with attractant gel on the glue surface.

- ✓ **SMALL AND DISCREET**
- ✓ **AROMA LICORICE**

CODE	PACK	OUTER CARTON
P-04094	20 pcs	SALES UNIT 100 pcs

**GLUE AREA** 70 x 115 mm



## SCAR4TRAP



Can be split in 4 small detectors. They can be easily placed to reach difficult areas thanks to the double sided tape on the back of the trap.

- ✓ **IDEALS TO REACH DIFFICULT AREAS**
- ✓ **AROMA LICORICE**

CODE	PACK	OUTER CARTON
P-04013	20 pcs (4 IN 1)	SALES UNIT 200 pcs

**GLUE AREA** 105 x 50 mm



## GEOTRAP PLASTIC

Pre-activated with attractant gel on the glue surface.

- ✓ **THE ONLY WATERPROOF COCKROACH TRAP.**
- ✓ **AROMA LICORICE**



CODE	PACK	OUTER CARTON
P-04002GEL	10 pcs	SALES UNIT 100 pcs

**GLUE AREA** 90 x 145 mm



## INSECT PAD

Small ready to use detector that can be placed inside **MONITOR GUARD** (P-04081).

- ✓ **AROMA LICORICE**

CODE	PACK	OUTER CARTON
P-04074	10 pcs	SALES UNIT 100 pcs

**GLUE AREA** 40 x 65 mm



## MONITOR GUARD



Rigid plastic station for monitoring cockroaches with the use of insect pad for **insect pad**.

✓ **CAN BE INSTALLED VERTICALLY ON SHELVES**

CODE	PACK	OUTER CARTON
P-04081	-	SALES UNIT 50 pcs

**IDEAL FOR:**  
INSECT PAD  
P-04074



## EASY BUGS



Passive adhesive trap to monitor *Cimex lectularius*. Once the insects access the device through the specially designed entrance holes, they get stuck on their backs rather than by the legs as it normally happens in traditional glue traps. This way bed bugs will perceive the trap as a harborage and will start emitting aggregation pheromone attracting other individuals of the same species.

✓ **DOUBLESIDED ADHESIVE STRIPS ARE INCLUDED IN THE PACKAGE AND CAN BE USED TO ATTACH THE TRAP TO SURFACES.**

CODE	PACK	OUTER CARTON
P-04181	10 pcs	SALES UNIT 50 pcs

**GLUE AREA** 77,5 x 25 mm

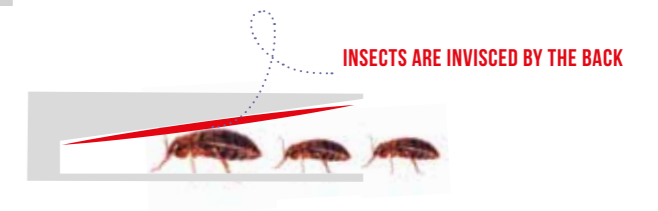

**THE EMISSION OF THE AGGREGATION PHEROMONE BY THE CAPTURED INSECTS ATTRACTS OTHER BED BUGS INSIDE THE TRAP.**

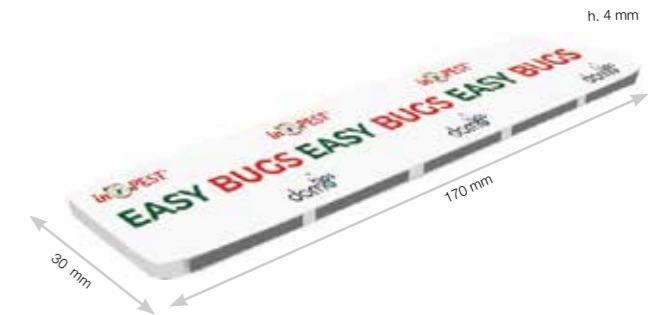

## BED BUGS TRAP



CODE	PACK	OUTER CARTON
P-04179	10 pcs	SALES UNIT 30 pcs

GLUE AREA 2 areas 70x40 mm each



## BED BUGS TAPE



Use around bed legs and in other bed bugs passageways. Use around bed legs and in other bed bugs passageways.

CODE	PACK	OUTER CARTON
P-04179TAPE	-	SALES UNIT 25 m



## MICE AND RATS

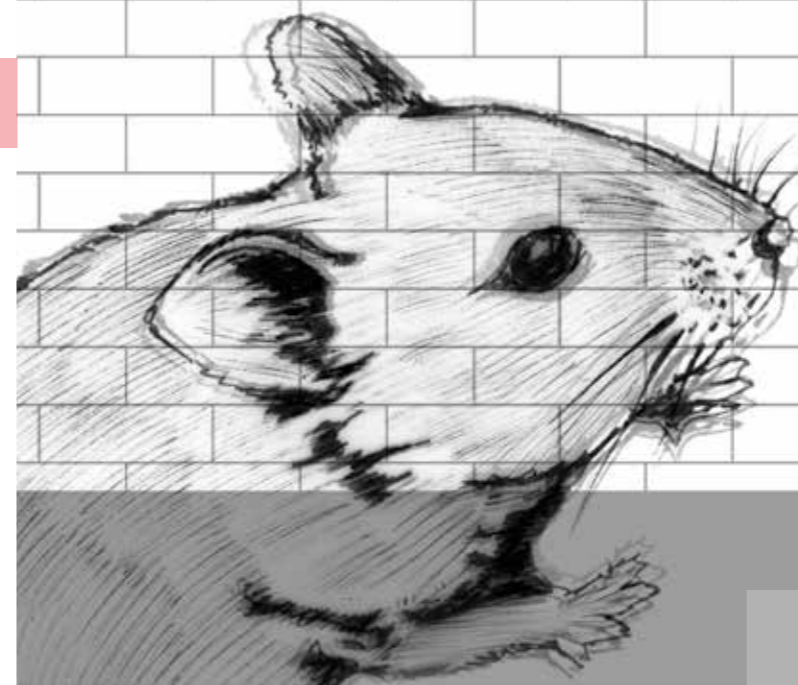

# MICE AND RATS

## WORK RESPONSIBLY.

The professional pest controller needs to become more and more aware of the fact that every time he/she uses tools for managing rodent infestations not only he/she affects the life of the target pest but also the one of non-target animals.

These non-target organisms may come into contact directly with the product or indirectly, for example when they get in contact with rodents that have been poisoned by rodenticides. This is why the use of glue, snap traps, live catch systems and rodenticides must be chosen and used with maximum care in order to reduce the risk of affecting non-target organisms.

A more conscious use of all the available rodent control tools will result in less suffering for pests and a more efficient long lasting result.

**inPEST** with its team of experts is engaged to raise awareness among its partners and customers of the importance of working according to these principles. In all those situations where the use of rodenticides is discouraged or forbidden, the use of glue boards (wooden glue boards, glue trays, cardboard glue boards, etc.) for managing rodents infestations is almost necessary.

The inPEST **MICE AND RATS GLUE BOARD LINE**, is designed with these principles in mind.

The numerous traps in the range guarantee multiple catches in any environmental condition.

This product line offers ideal solutions both in professional areas (such as food industries, warehouses, hospitals, etc.) and

urban areas such as condominiums, offices, homes etc. In an integrated pest management (IPM) program the combined use of glue traps and rodenticides allows the professional PCO to catch poisoned rodents before they die avoiding situations in which rotting carcasses remain lying unnoticed causing unpleasant drawbacks (bad odors, secondary infestations of saprophagous/ necrophagous insects etc.).

By placing the traps along the passageways of rodents, these will get caught while moving between their hiding place and their food

source. The inPEST mice and rats line includes also multiple catch stations, rodenticide bait boxes and snap traps to meet all different requirements.

## STORAGE CONDITIONS OF GLUE TRAPS:

Stored in a cool and dry place (lower than 25°C / 77°F and 55% R.H.) in their original packaging.

Products are guaranteed to perform correctly up to 3 years.

NO TARGET OIL BOTTLE  
UNIVERSAL GLUEBOARD  
STOP MINI  
T-STOP  
ULTRA STOP  
BOOK REFILL  
UNIVERSAL GB PLASTIC  
STOP MINI PLASTIC  
WATERPROOF TRAP  
WATERPROOF BOX  
ECOTRAP MAXI BLACK  
ECOTRAP MAXI WHITE  
TUNNEL MAXI  
ECOTRAP QUADRO MINI  
TUNNEL QUADRO MINI  
REFILL BOARD MINI  
REFILL BOARD MAXI  
GALVANISED TUNNEL FOR REFILL BOARD  
UNIBOX BLACK  
UNIBOX TRANSPARENT  
MULTI CATH METAL  
MULTI CATCH PLASTIC  
RAT SNAP TRAP EVO  
MR. GEL  
CORAL  
BETA2  
RODENT STOP TRANSPARENT  
ROCK BAIT STATION

IN THE FOLLOWING PAGES YOU WILL FIND BEST PRACTICES FOR THE RATIONAL AND RESPONSIBLE USE OF GLUE TRAPS: BY FOLLOWING THEM YOU CAN MINIMISE THE SUFFERING OF PEST RODENTS AND AVOID CATCHING NO-TARGETS.



## BEST PRACTICE DECALOGUE FOR A SUSTAINABLE HANDLING OF THE RODENT'S GLUES.

In this protocol we define the Rodent Glue Traps as "any surface covered by glue specifically used to trap rodents" and we consider the following points:

- 1 Assess the risk level: Before beginning to evaluate the possibility of other control methods, by suitability and results achieved in similar cases.
- 2 Only trained and competent professionals should be involved: responsible and certified PCOs
- 3 Frequent Monitoring: after no longer than 12 hours after installing the trap to minimize target's suffering and to release any no Target. Yet to be trained operators can do the monitoring but under direct responsibility of the Pest Manager. Glue traps should only be used indoor and never outdoor.
- 4 Need for a contingency plan: indicate a second person capable of carrying out all the work; if there are problems with the inspection schedule, the action must be suspended and the traps uninstalled, albeit temporarily.
- 5 Install traps of a size suitable for the target species and protected by appropriate covers.
- 6 Properly record all position, timing, catch, discharge data and keep them available and copied.
- 7 Suppress the target as quickly as possible (no drowning).
- 8 Protect non-target animals with devices properly positioned and covered with protective tunnels, as well as having suitable diluents and emollients available to properly release any trapped specimens, always in cooperation with specialists for the rescuing of non-target animals.
- 9 All devices must be removed at the end of treatments and recorded on the worksheet.
- 10 Proper disposal according to current regulations, keeping track of it in the project records.

*Best practice* in the workplace  
must include

» **NOTARGET  
OIL BOTTLE** »

Your ally for sustainable  
glue trap management

### NO TARGET OIL BOTTLE

A 250 ml bottle of paraffin oil. Enables the release of NO TARGETs caught in glue traps.

CODE	P-09078
PACK	1 bottle, 250 ml
OUTER CARTON	Sales unit 5 pcs

The inPEST solution in accordance with  
best practices for use and responsible  
use of products.



## UNIVERSAL GLUEBOARD

To monitor *Mus domesticus*, other small size rodents and crawling insects.

- ✓ CHERRY AROMA
- ✓ SUITABLE FOR MICE AND ALSO FOR COCKROACHES

CODE	PACK	OUTER CARTON
P-02038	-	SALES UNIT <b>140 pcs</b>

GLUE AREA PALLET **80 x 132 mm**  
29400 pcs, 80x120x140h

IDEAL FOR:



UNIBOX BLACK  
P-03039



UNIBOX TRANSPARENT  
P-03039T



## STOP MINI

Monitoring glue board to be used inside multiple catch boxes. To monitor *Mus domesticus* and other small size rodents and crawling insects.

- ✓ ALSO AVAILABLE WITH HAZELNUT AROMA
- ✓ SUITABLE FOR MICE AND ALSO FOR COCKROACHES

CODE	PACK	OUTER CARTON
P-02009B BANANA	<b>10 pcs</b>	SALES UNIT <b>140 pcs</b>
P-02009N HAZELNUT		

GLUE AREA PALLET **80 x 180 mm**  
14000 pcs, 80x120x175h

IDEAL FOR:



MULTI CATCH PLASTIC  
P-03002



MULTI CATCH METAL  
P-03036

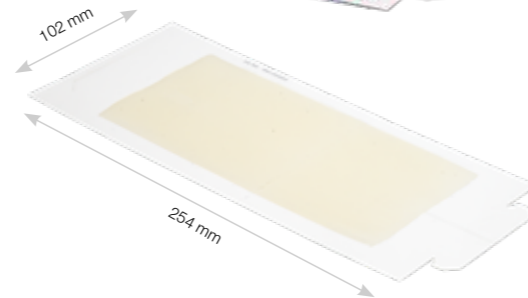

## T-STOP

Larger glue area to optimize use inside multiple catch boxes. To monitor *Mus domesticus* and other small size rodents and crawling insects.

- ✓ BANANA AROMA
- ✓ SUITABLE FOR MICE AND ALSO FOR COCKROACHES

CODE	PACK	OUTER CARTON
P-02001	<b>10 pcs</b>	SALES UNIT <b>100 pcs</b>

GLUE AREA PALLET **90 x 180 mm**  
14000 pcs, 80x120x160h



IDEALE PER:



MULTI CATCH METAL  
P-03036



MULTI CATCH PLASTIC  
P-03002

## ULTRA STOP

The cardboard glue trap with the largest glue surface in the range. To monitor *Mus domesticus*, other small size rodents and crawling insects.

- ✓ HAZELNUT AROMA
- ✓ SUITABLE FOR MICE AND ALSO FOR COCKROACHES

CODE	PACK	OUTER CARTON
P-02017	-	SALES UNIT <b>50 pcs</b>

GLUE AREA PALLET **110 x 155 mm**  
10500 pcs, 80x120x140h



## BOOK REFILL

Carton trap, the only rodent glue trap on the market that can be locked in a tunnel shape. The precuts in the cardboard allow to configure the trap in many ways.

✓ HAZELNUT AROMA

✓ TRAP FOR RAT AND MICE

CODE	PACK	OUTER CARTON
P-02019	2 pcs	SALES UNIT 60 pcs

GLUE AREA 250 x 160 mm

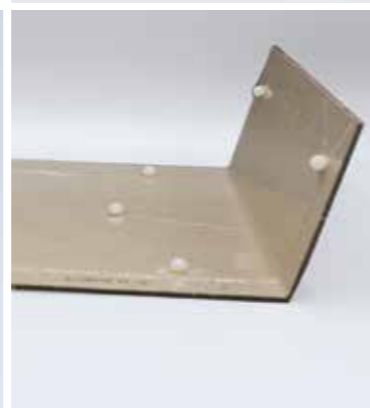
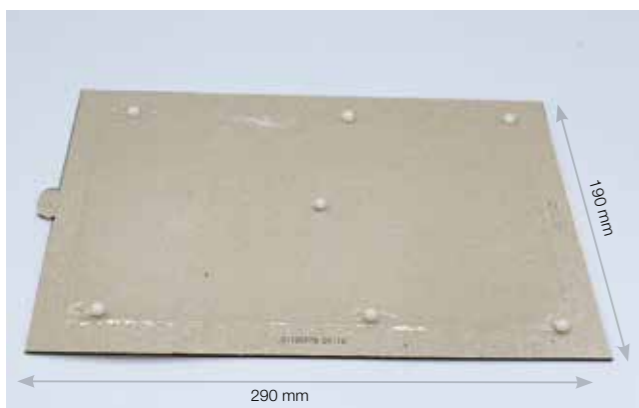
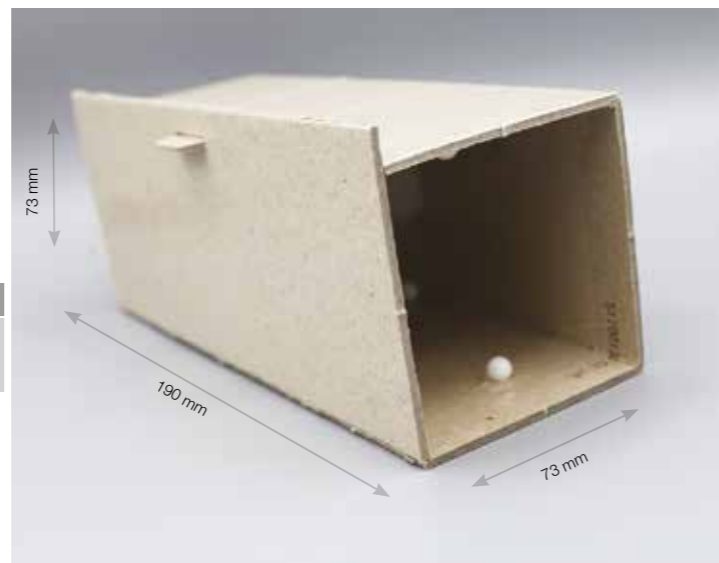

USABLE WITH:

BETA 2  
P-03019



✓ Ideal for use in damp and humid areas where surfaces are often wet due to constant washing (e.g. cheese factories, cafeterias, food industries etc.).

## UNIVERSAL GB PLASTIC

WATERPROOF



To monitor *Mus domesticus*, other small size rodents and crawling insects.

✓ CHERRY AROMA

✓ SUITABLE FOR MICE AND ALSO FOR COCKROACHES

CODE	PACK	OUTER CARTON
P-02038PT	-	SALES UNIT 100 pcs

GLUE AREA 80 x 132 mm  
PALLET 21000 pcs, 80x120x140h



IDEAL FOR:



UNIBOX BLACK  
P-03039



UNIBOX TRANSPARENT  
P-03039T

## STOP MINI PLASTIC

WATERPROOF



Monitoring glue board to be used inside multiple catch boxes. To monitor *Mus domesticus* and other small size rodents and crawling insects.

✓ BANANA AROMA

✓ SUITABLE FOR MICE AND ALSO FOR COCKROACHES

CODE	PACK	OUTER CARTON
P-02009BH	5 pcs	SALES UNIT 100 pcs

GLUE AREA 180 x 80 mm  
PALLET 10000 pcs, 80x120x150h

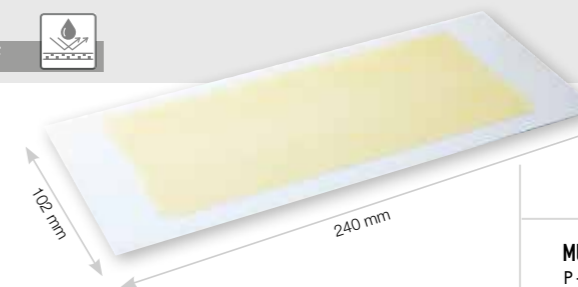

MULTI CATCH METAL  
P-03036

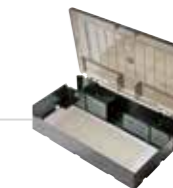

MULTI CATCH PLASTIC  
P-03002

## WATERPROOF TRAP

WATERPROOF



HOLES FOR FIXING WITH CLAMP

Glue trap in corrugated plastic with holes for fixing with electrical zip ties. To monitor *Mus domesticus*, other small size rodents and crawling insects.

- ✓ SUITABLE FOR MICE AND ALSO FOR COCKROACHES

CODE	PACK	OUTER CARTON
P-02014	10 pcs	SALES UNIT 50 pcs

GLUE AREA 150 x 160 mm  
PALLET 1600 pcs, 80x120x165h



## WATERPROOF BOX

WATERPROOF



Multi-catch trap in corrugated plastic with holes for fixing with electrical zip ties.

- ✓ WITHOUT GLUE
- ✓ SUITABLE FOR MICE AND ALSO FOR COCKROACHES

CODE	PACK	OUTER CARTON
P-02016	10 pcs	SALES UNIT 50 pcs

GLUE AREA without glue  
PALLET 1600 pcs, 80x120x165h

IDEAL FOR:



UNIVERSAL GB  
P-02038



UNIVERSAL GB PLASTIC  
P-02038PT



## ECOTRAP MAXI

Monitoring devices used to monitor the presence of larger size rodents like *Rattus rattus* (roof rat), *Rattus norvegicus* (sewer rat). These traps can also be used to monitor smaller size rodents. Trays can also be equipped with a plastic cover (tunnel) which is sold separately.

- ADVANTAGES:
- ✓ PALLEWS MULTIPLE CATCHES
  - ✓ DUST RESISTANT GLUE
  - ✓ IDEAL FOR LOW TEMPERATURES

WATERPROOF



## ECOTRAP MAXI BLACK

- ✓ HAZELNUT AROMA
- ✓ TRAP FOR RAT AND MICE

CODE	PACK	OUTER CARTON
P-02004G40	2 pcs (SPOT WELDED TOGETHER FOR EASE OF USE)	SALES UNIT 100 pcs (50 packs.)

PALLET 3200 pcs, 80x120x175h



IDEAL FOR:



TUNNEL MAXI  
P-02020



RODENT STOP TRANSPARENT  
P-03065T

## ECOTRAP MAXI WHITE

- ✓ HAZELNUT AROMA
- ✓ TRAP FOR RAT AND MICE

CODE	PACK	OUTER CARTON
P-02004G40B	2 pcs (SPOT WELDED TOGETHER FOR EASE OF USE)	SALES UNIT 100 pcs (50 packs.)

PALLET 3200 pcs, 80x120x175h



## TUNNEL MAXI

WATERPROOF



To protect glue trays from dust and water and to exploit rodents behavior to run in narrow places for harborage.

CODE	PACK	OUTER CARTON
P-02020	1 pc	SALES UNIT 100 pcs

PALLET 3200 pcs, 80x120x175h

IDEALE PER:



ECOTRAP MAXI  
BLACK: P-02004G40  
WHITE: P-02004G40B



Example of good rodent control practices.  
Traps should be protected by a cover.



## ECOTRAP QUADRO MINI

WATERPROOF



White glue tray to monitor the presence of *Mus domesticus* and other small size rodents.  
PLASTIC COVER (TUNNEL) SOLD SEPARATELY

- ✓ HAZELNUT AROMA
- ✓ TRAP FOR RAT AND MICE

CODE	PACK	OUTER CARTON
P-02013B	4 pcs (SPOT WELDED TOGETHER FOR EASE OF USE)	SALES UNIT 200 pcs (50 packs)

PALLET 6400 pcs, 80x120x175h



## TUNNEL QUADRO MINI

WATERPROOF



To protect glue trays from dust and water and to exploit rodents behavior to run in narrow places for harborage.

CODE	PACK	OUTER CARTON
P-02047	1 pc	SALES UNIT 100 pcs

PALLET 3200 pcs, 80x120x175h

IDEAL FOR:



ECOTRAP QUADRO  
MINI  
P-02013B



MDF hardboards for temporary corrective actions. Ideal for livestock industries.

## REFILL BOARD MINI

To monitor *Mus domesticus* and other small size rodents.

✓ HAZELNUT AROMA

CODE	PACK	OUTER CARTON
P-02031	2 pcs IN TRANSPARENT SHRINKWRAP	SALES UNIT 96 pcs (48 packs)

GLUE AREA 115 x 155 mm  
PALLET 4608 pcs, 80x120x120h

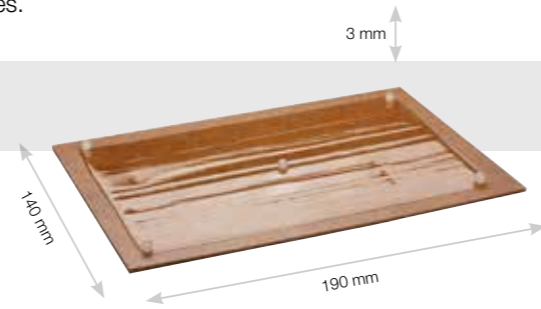

## REFILL BOARD MAXI

More glue to monitor rodents like *Rattus rattus* and *Rattus norvegicus*. The device can also be used to monitor smaller size rodents.

✓ HAZELNUT AROMA

✓ TRAP FOR RAT AND MICE

CODE	PACK	OUTER CARTON
P-02005	2 pcs IN TRANSPARENT SHRINKWRAP	SALES UNIT 48 pcs (24 packs)

GLUE AREA 160 x 250 mm  
PALLET 2304 pcs, 80x120x120h



## GALVANISED TUNNEL FOR REFILL BOARD

Protective metal tunnel made of galvanised sheet metal with a trapezoidal cross-section to protect the glue boards from dust and as a protective filter for non-target organisms.

CODE	PACK	OUTER CARTON
P-02064	1 pc	SALES UNIT 5 pcs

IDEAL FOR:

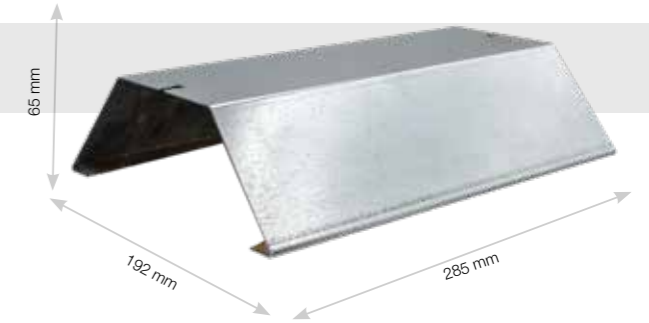

Example of good rodent control practices. Traps should be protected by a cover.



inPEST's mice and rats boxes line includes three categories:  
boxes for inPEST glue boards, boxes for snap traps and boxes for rodenticide/virtual bait.

## UNIBOX

**MULTIPLE CATCH BOX** to monitor the presence of mice (*Mus domesticus* and small size rodents) cockroaches (*Blattella germanica*, *Blatta orientalis* and *Periplaneta americana*).  
It has **10 ENTRANCE HOLES** for crawling insects and **2 ENTRANCE** holes for mice.  
The entrance holes for mice can be "activated" by breaking the plastic along the dotted line and expanding the hole to 25 mm diameter.

THE BOX IS OPENED WITH A SAFETY KEY (INCLUDED).

### UNIBOX BLACK

CODE	OUTER CARTON
P-03039	SALES UNIT 20 pcs
PALLET	1040 pcs, 80x120x165h

SUITABLE FOR MICE AND ALSO FOR COCKROACHES

10 ENTRANCE HOLES

2 ENTRANCE HOLES FOR MICE

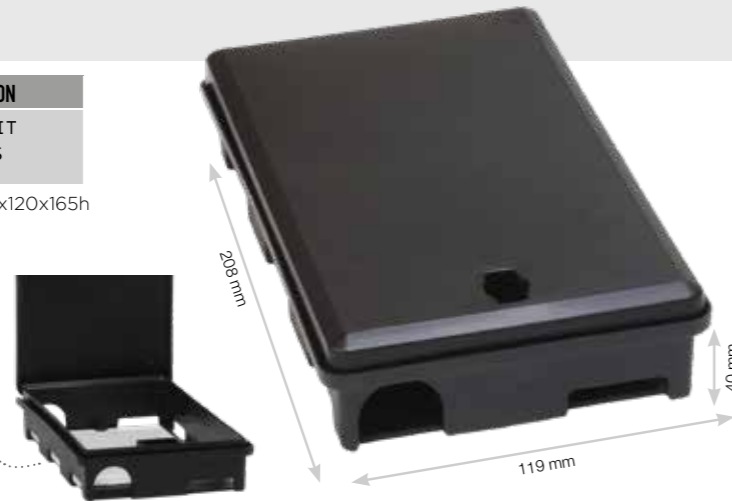

IDEAL FOR:



UNIVERSAL GB  
P-02038



UNIVERSAL GB PLASTIC  
P-02038PT



CABLE TIE MD  
P-08033

### UNIBOX TRANSPARENT

THE CLEAR PLASTIC ALLOWS AN IMMEDIATE VISUAL INSPECTION. IDEAL FOR SENSIBLE AREAS.

CODE	OUTER CARTON
P-03039T	SALES UNIT 20 pcs

SUITABLE FOR MICE AND ALSO FOR COCKROACHES



## MULTI CATCH METAL

Metal container to be used with glued traps for the monitoring of **small rodents and crawling insects**.

The transparent lid allows for immediate visual inspection.

It consists of **2 entrances with a mechanical lever system that prevents the rodents** from escaping. Side holes allow access to cockroaches.

Now improved to allow easier fixing and locking of the trap.

SUITABLE FOR MICE and ALSO FOR COCKROACHES

CODE	OUTER CARTON
P-03036	SALES UNIT 12 pcs
PALLET	480 pcs, 80x120x170h

IDEAL FOR:



T-STOP  
P-02001



STOP MINI  
P-02009B  
P-02009N



STOP MINI PLASTIC  
P-02009BH



CABLE TIE MD  
P-08033

FIXING SYSTEM



LATERAL



INSPECTION WINDOW



## MULTI CATCH PLASTIC

Plastic multiple catch box **to be used with monitoring glue boards**.

The clear lid allows an immediate visual inspection. It is composed of **2 entrances with a mechanical lever system that prevent the rodents from escaping**. Lateral holes allow access to cockroaches.

 **SUITABLE FOR MICE AND ALSO FOR COCKROACHES**

CODE	OUTER CARTON
P-03002	SALES UNIT <b>12 pcs</b>

PALLET **480 pcs, 80x120x185h**

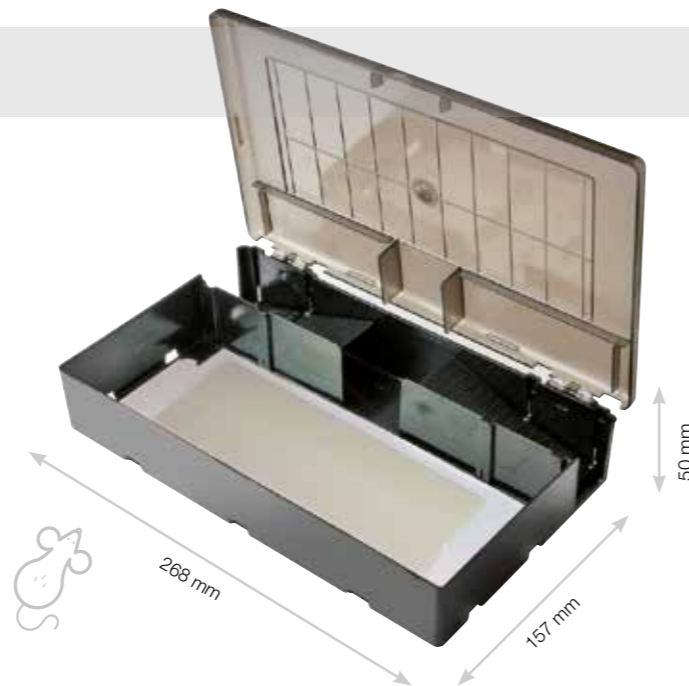

IDEAL FOR:



T-STOP  
P-02001



STOP MINI  
P-02009B  
P-02009N



STOP MINI PLASTIC  
P-02009BH

Snap traps for mice and rats **are a valid alternative to the use of rodenticides and cause the death of the rodent in a very short time.**

It is possible to add an aroma dispenser in the traps. Suitable for indoor and outdoor use.

## RAT SNAP TRAP EVO

Can be armed safely.  
Equipped with holes for fixing.

 **TRAP FOR RAT AND MICE**

CODE	OUTER CARTON
P-03009	SALES UNIT <b>24 pcs</b>



IDEAL FOR:



BETA 2  
P-03019

## CORAL

**Polypropylene bait** station for monitoring the presence of mice (*Mus domesticus* and other harmful rodents) and rats (*Rattus rattus*, *Rattus norvegicus*).

**Composed of 2 entrances**, security lock with appropriate key supplied, internal rod for the positioning and fixing of the rodenticide / virtual bait. Spacer and internal removable tray included.

✓ TRAP FOR RAT AND MICE

CODE	OUTER CARTON
P-03024	SALES UNIT 30 pcs (30 SAFETY KEYS INCLUDED)

PALLET 480 pcs, 80x120x155h



## BETA 2

**Polypropylene bait** station especially suitable for outdoor use.

**Equipped with 2 entrance holes**, dedicated safety key for the double locking system which make the box even safer, internal metal rod for fixing rodenticide or virtual bait.

**Spacer and internal removable tray included.**

✓ TRAP FOR RAT AND MICE

CODE	OUTER CARTON
P-03019	SALES UNIT 20 pcs (20 SAFETY KEYS INCLUDED)

PALLET 240 pcs, 80x120x155h



High density polypropylene bait station for rodenticide or virtual bait. THE TRAPEZOID SHAPE ALLOWS EASY POSITIONING AGAINST WALLS.

## RODENT STOP TRANSPARENT

**For immediate visual inspection.**  
Ideal in sensitive areas.

✓ TRAP FOR RAT AND MICE

CODE	OUTER CARTON
P-03065T	SALES UNIT 12 pcs (1 SAFETY KEYS INCLUDED)



IDEAL FOR:



**ECOTRAP MAXI**  
BLACK: P-02004G40  
WHITE: P-02004G40B

## ROCK BAIT STATION

The peculiar shape and color recall that one of a **rock and can camouflage the bait station in natural environments.**

Equipped with 2 entrance holes, an extractable bait tray and a kit to fix the box in the soil.

✓ TRAP FOR RAT AND MICE

CODE	OUTER CARTON
P-03025	SALES UNIT 12 pcs (12 SAFETY KEYS INCLUDED)

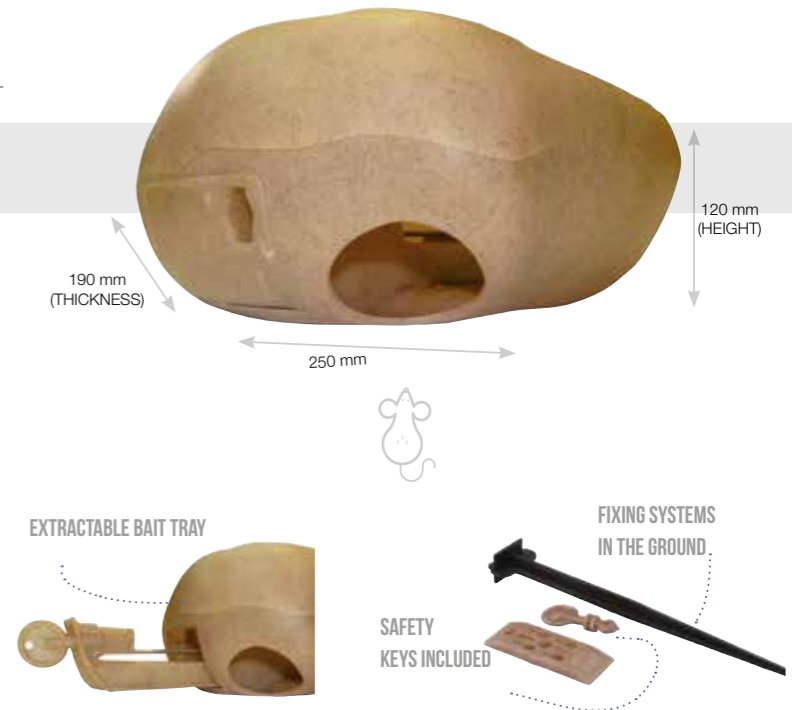

EXTRACTABLE BAIT TRAY

FIXING SYSTEMS IN THE GROUND

SAFETY KEYS INCLUDED

## MULTIPLE CATCH COMPARISON

MULTI CATCH  
PLASTIC  
P-03002



MULTI CATCH  
METAL  
P-03036



UNIBOX  
BLACK  
P-03039



UNIBOX  
TRANSPARENT  
P-03039T



## MICE AND RAT BAIT STATIONS COMPARISON

CORAL  
P-03024



BETA 2  
P-03019



RODENT STOP  
TRANSPARENT  
P-03065T



ROCK BAIT STATION  
P-03025



## FLIES, WASPS AND FRUITFLIES

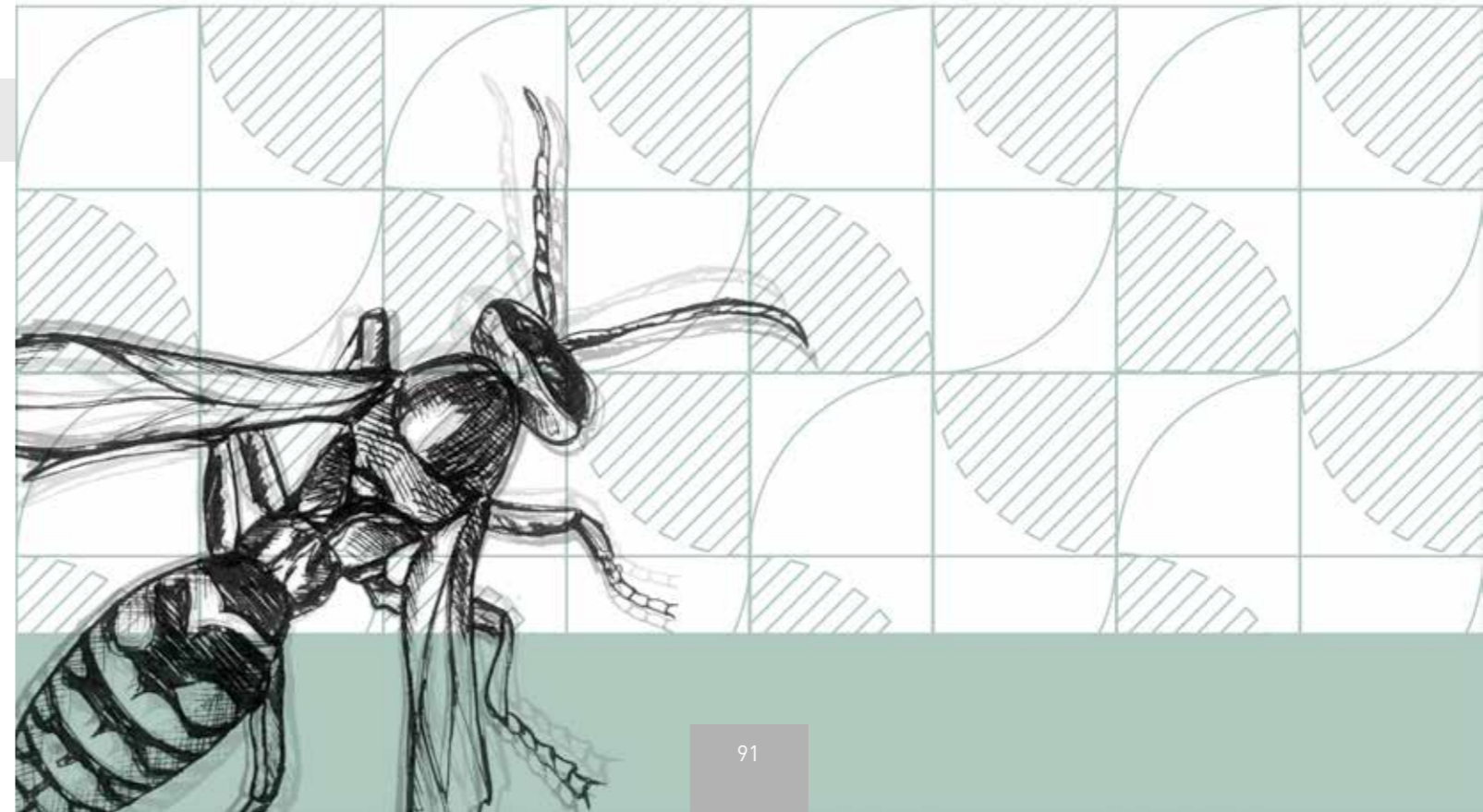

# FLIES, WASPS AND FRUITFLIES

**inPEST flies, wasps, fruit flies/vinegar flies**, mosquitoes line is composed of a series of valid tools to manage infestations in open spaces such as balconies, gardens, orchards or in those areas where beer, wine, alcohol, sugar, etc. are stocked and processed.

**Target:**  
*Drosophila spp., Musca domestica, Lucilia caesar, Calliphora vomitoria, Sarcophaga carnaria, Vespidae* in general.

- APPLE TRAP
- APPLE DUST
- VESPOKIL
- CROMOPLUS WING
- DROSOCYL
- OVIPOSITION STICK
- TRAP BAG

## APPLE TRAP

Funnel entrance for ease of access to insects.

✓ Position at 1,5 m (approx. 5 ft) above ground.

CODE	PACK	OUTER CARTON
P-04025	-	SALES UNIT 10 pcs



## APPLE DUST

Food based powder for monitoring flies.

✓ IDEAL TO USE WITH APPLE TRAP

CODE	OUTER CARTON	PALLET
P-01027	35 g plastic bag	SALES UNIT 20 pcs



ANIMAL PROTEIN MEAL

## VESPOKIL

Food based liquid for monitoring wasps and hornets. Color change and/or separation of ingredients inside the bottle do not compromise the efficacy. Always shake well before use.

**ALWAYS SHAKE THE PRODUCT BEFORE USE.**

CODE	CAPACITY	OUTER CARTON
P-01011	1 bottle, 500 ml	SALES UNIT 12 pcs

SIZE OF BOTTLE: 70 x 170 (h) mm; bottle of 500 ml

✓ IDEAL TO USE WITH APPLE TRAP



## CROMOPLUS WING

Corrugated plastic trap for monitoring fruit and vinegar flies.

**NEW SHAPE MORE EASY TO ASSEMBLE**

CELLULOSE CYLINDER NOT INCLUDED.

CODE	PACK	OUTER CARTON
P-04056	1 pc	SALES UNIT 6 pcs

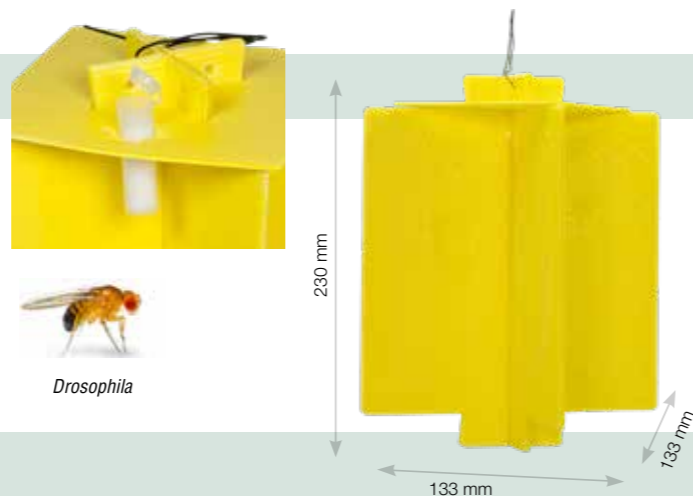

## DROSOCYL

PE plastic vial containing a cellulose cylinder impregnated with attractant for fruit and vinegar flies.

✓ VIAL MUST BE USED OPEN.

CODE	PACK	OUTER CARTON
P-01010	1 pc	SALES UNIT 6 pcs



NEW STRENGTHENED FORMULATION

## MOSQUITOES

## OVIPOSITION STICK

Place inside a dark container with water (let top part of the stick come out of the container as shown).

CODE	PACK	OUTER CARTON
P-04208	-	SALES UNIT 50 pcs



## TRAP BAG

Disposable trap with capacity **3 liters** for mass capture of flies.

The trap is activated with specific food powder in a **water-soluble** bag and **1.5 litres** of water.

Water-soluble bag already present in the trap.

CODE	PACK	OUTER CARTON
P-04108	1 pc	SALES UNIT 10 pcs



## ILTs, LED UV TRAPS, UV TUBES AND GLUE BOARDS

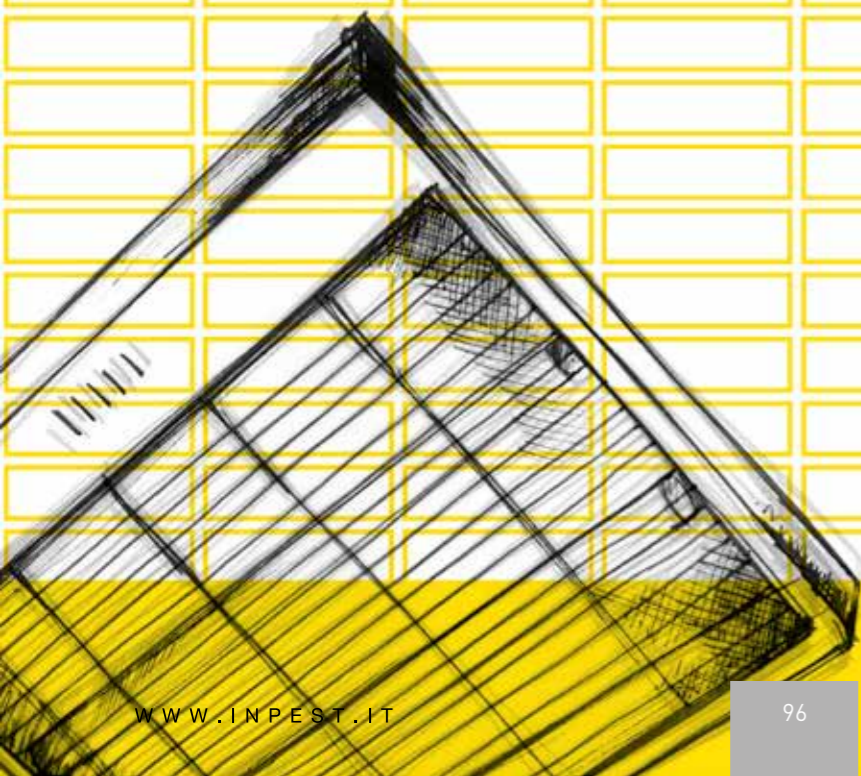

# INSECT LIGHT TRAPS (ILTs), U.V. TUBES, LED AND GLUE BOARDS

By law foodstuffs must not be contaminated by external agents such as insects and other infestants. inPEST Insect Light Traps (ILTs) line offers electronic light trap with glue boards and U.V. tubes that lure flying insects and trap them preventing them from contaminating foodstuffs at the same time allowing PCOs to monitor these pests efficiently. To manage flying insects infestations the position of the insect light trap is not the only important thing to take into account, it is also very important to choose the right device for the area that needs monitoring. If devices are placed in the wrong way or are poor quality units they can give an unfounded sense of confidence making the situation worse.

### Target:

Flies, mosquitoes, wasps and hornets and all flying insects with positive phototropic response (i.e. attracted by light).

### POSITIVE PHOTOTROPISM SPECIES OF GREATEST INTEREST IN THE FOOD INDUSTRY

#### Lepidoptera - Food Moths

*Sitotroga cerealella* - *Plodia interpunctella*  
*Ephestia kuehniella* - *Ephestia cautella*  
*Nemapogon granella* - *Corcyra cephalonica*

#### Coleoptera - Food Beetles

*Tribolium castaneum* - *Tenebrio molitor*  
*Lasioderma serricornis* - *Stegobium paniceum*  
*Oryzaephilus surinamensis* - *Oryzaephilus mercator*  
*Rhyzopertha dominica* - *Antherenus spp.*  
*Attagenus spp.* - *Cryptolestes spp.*

#### Diptera - Fly, green and blue flyflies, carnaria fly

*Calliphora spp.* - *Lucilia spp.* - *Drosophila spp.*  
*Musca domestica* - *Sarcophaga carnaria*

#### Hymenoptera - Wasps and hornets

*Vespa crabro* - *Vespula spp.* - *Polysles spp.*

#### Hemiptera - Bugs

*Nezara viridula* - *Palomena prasina*  
*Halyomorpha halys*

The indicated coverage is indicative.

The area of effect of the U.V. fly killers may vary based on how objects are placed in the surrounding environment.

# INSECT LIGHT TRAPS (ILTs), U.V. TUBES, LED AND GLUE BOARDS

## LAMPADE U.V.

### FLY VARIO

Lamp in stainless steel and plastic.

It is equipped with 2 neon 15W lights shatterproof inPEST.

Can be used on the wall in multiple positions, or suspended.

Front inclination adjustable in **3 positions**.



CODE	P-06119V
GLUE AREA	75 - 100 m <sup>2</sup>
OUTER CARTON	Sales unit, 1 pc

USED ON THE WALL IN MULTIPLE POSITIONS

#### REPLACEMENT PARTS:

FLY VARIO YELLOW  
6 pz P-I06355GC

NEON 15 W BL 368 nm  
STANDARD  
P-06011NPH

NEON 15 W STRAIGHT  
SHATTERPROOF FEP  
inPEST BL 368 nm  
P-06011SPIN

NEON 15 W STRAIGHT  
SHATTERPROOF FEP  
BL 368 nm  
P-06186SP

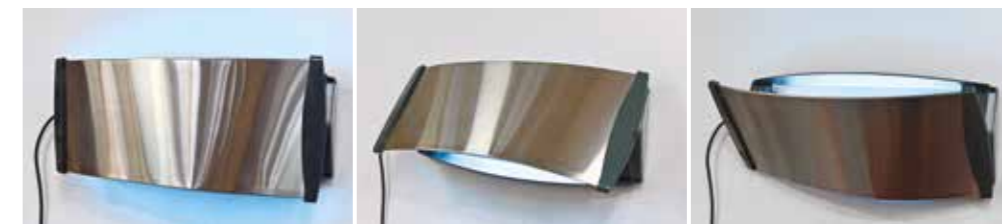

ADJUSTABLE  
FRONT PART  
IN 3 POSITIONS



USABLE SUSPENDED



IN VERTICAL

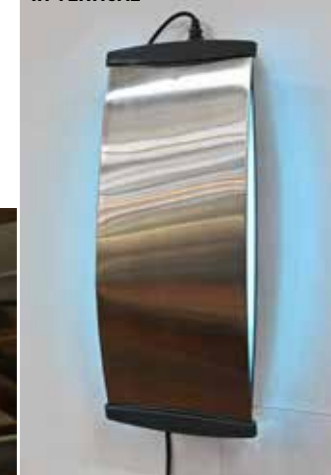

FLY VARIO  
MONITOR FLY - MONO SHATTERPROOF  
MONITOR FLY - DOUBLE SHATTERPROOF  
MONITOR FLY LED - BIFACCIALE  
ARACNO  
COFFEE LIGHT EVO  
METAL HANGER

**NEW**

LAMPADE U.V.

## MONITOR FLY – MONO SHATTERPROOF

It is equipped with 2 neon shatterproof FEP inPEST da 15W.

✓ CAN BE MOUNTED ON THE WALL

CODE	P-06097
GLUE AREA	100 - 150 m <sup>2</sup>
OUTER CARTON	Sales unit, 1 pc

<b>MONITOR FLY MONO</b> BLACK 12 pz P-G06044FNC	<b>MONITOR FLY MONO</b> YELLOW 12 pz P-G06044FGC
---	--



## MONITOR FLY – DOUBLE SHATTERPROOF

The unit is equipped with 4 shatterproof 15W straight tubes.

✓ CAN BE WALL MOUNTED WITH THE USE OF METAL HANGER

CODE	P-06096
COVERAGE	200 - 250 m <sup>2</sup>
OUTER CARTON	sales unit 1 pc
PALLET	36 pcs, 80x120x160h



CAN BE USED WITH:

REPLACEMENT PARTS:

<b>MONITOR FLY MONO</b> BLACK 12 pz P-G06003FN2C	<b>MONITOR FLY MONO</b> YELLOW 12 pz P-G06003FG2C	<b>NEON 15W</b> STANDARD BL 368 nm P-06011N	<b>NEON 15W STRAIGHT</b> SHATTERPROOF FEP INPEST BL 368 nm P-06011SPIN	<b>NEON 15W STRAIGHT</b> SHATTERPROOF FEP BL 368 nm P-06186SP
--	---	---	---	--



## MONITOR FLY LED – BIFACCIALE

LED lamp equipped with 4 LED tubes with shatterproof anti-fragmentation film. "ELECTRONIC" LED replacement parts. Can be used on the wall or suspended.

CODE	P-06191
COVERAGE	200 m <sup>2</sup>
OUTER CARTON	sales unit 1 pc

GRATE THAT CAN BE RAISED AND CLOSED USING A MAGNET



NEW DESIGN LIGHTER AND MORE COMPACT

ANCHOR HOOKS TO SECURE IT TO THE WALL OR HANG IT USING A CHAIN

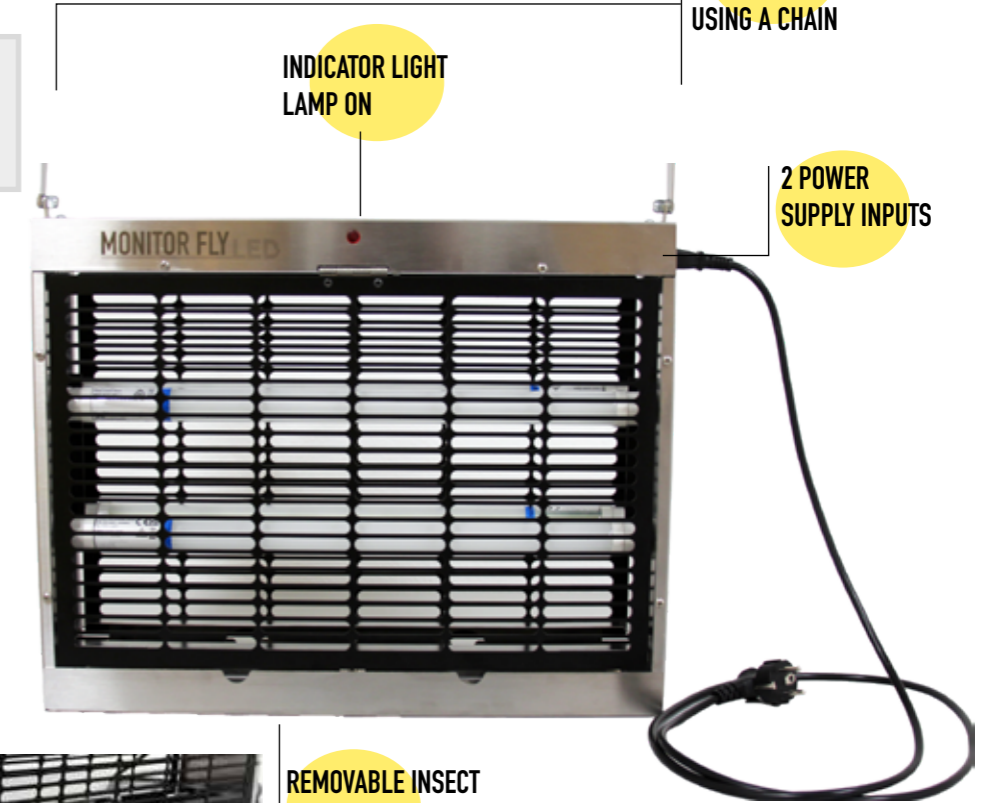

REPLACEMENT PARTS:

<b>MONITOR FLY MONO</b> BLACK 12 pz P-G06044FNC	<b>MONITOR FLY MONO</b> YELLOW 12 pz P-G06044FGC	<b>MOONLED TUBO LED</b> UV T8 5W P-061905PIN
---	--	--

INSECT LIGHT TRAPS (ILTs)

## ARACNO

The unit is equipped with 2 standard 15W straight tubes.

**Can be wall or tabletop mounted.**

Available also a version with Neon 15w shatterproof (P-06011SPIN).

CODE	P-06112
COVERAGE	75 m <sup>2</sup>
OUTER CARTON	sales unit <b>1 pc</b>
PALLET	<b>36 pcs</b> , 80x120x170h



REPLACEMENT PARTS:

ARACNO - COMMERCIAL  
BLACK 6 pz  
P-G06199FNC

ARACNO - COMMERCIAL  
YELLOW 6 pz  
P-G06199FGC

NEON 15W STANDARD  
BL 368 nm  
P-06011N

NEON 15W STRAIGHT  
SHATTERPROOF FEP  
INPEST BL 368 nm  
P-06011SPIN

15W STRAIGHT  
SHATTERPROOF FEP BL  
368 nm  
P-06186SP

## COFFEE LIGHT EVO

Stainless steel unit with mirror finishing. The unit is equipped with 1 standard 20W tight U bend tube with integrated ballast.

**CAN BE WALL OR TABLETOP MOUNTED**

CODE	P-06124
COVERAGE	50 m <sup>2</sup>
OUTER CARTON	Sales unit, <b>1 pc</b>



REPLACEMENT PARTS:

COFFEE LIGHT  
WHITE CONF. 6 pz  
P-B06128FSC

20W NEON MINI LYNX BL  
368 nm STANDARD  
P-06129

20W NEON MINI LYNX BL  
368 nm SHATTERPROOF  
P-06125SP

INSECT LIGHT TRAPS (ILTs) - complementary products

## METAL HANGER

Steel support rod ideal for MONITOR FLY DOUBLE.





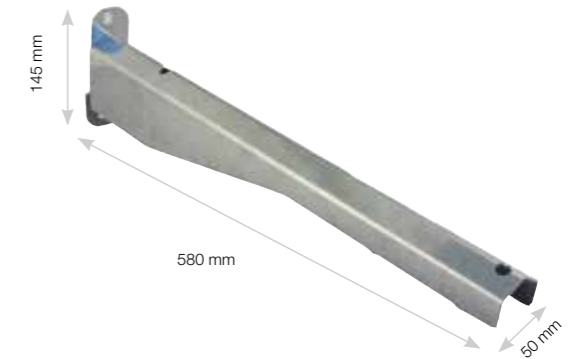

Equipped with screws and dowels for installation.

CODE	P-06003
PACK	-
OUTER CARTON	Sales unit, <b>1 pc</b>















NEON



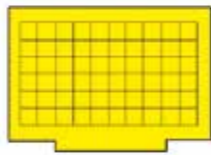
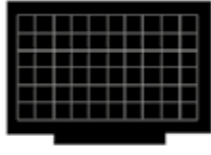

In the inPEST U.V. tubes line you can find standard and shatterproof U.V. tube with a 386 nm emission. Shatterproof tubes are all wrapped in virgin FEP to avoid glass shards from dispersing in case of accidental breakage. **IMPORTANT:** it is suggested to replace tubes every 12 months to maintain optimal U.V. emission.

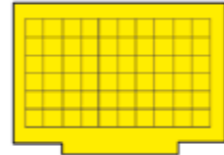
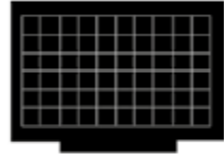

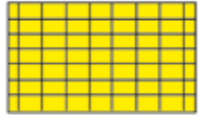

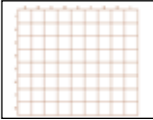
CODE		OUTER CARTON	
P-06011NPH	<b>neon 15W straight standard</b> size: 438 mm x Ø 26 mm base: G13 BL 368 nm (black light)	25 pcs	
P-06011SPIN	<b>neon 15W straight shatterproof inPEST</b> size: 438 mm x Ø 26 mm base: G13 BL 368 nm (black light) Virgin FEP sleeve.	25 pcs	
P-06186SP	<b>neon 15W straight shatterproof</b> size: 438 mm x Ø 26 mm base: G13 BL 368 nm (black light) Virgin FEP sleeve.	25 pcs	
P-06029SP	<b>neon 18W straight shatterproof</b> size: 600 mm x Ø 26 mm base: G13 BL 368 nm (black light) Virgin FEP sleeve.	25 pcs	
P-06016NASP	<b>neon 20W narva</b> size: 600 mm x Ø 38 mm base: G13 BL 368 nm (black light) Virgin FEP sleeve.	25 pcs	
P-06062SP	<b>neon 36W straight shatterproof</b> size: 600 mm x Ø 26 mm base: G13 BL 368 nm (black light) Virgin FEP sleeve.	25 pcs	
P-06017NASP	<b>neon 40W narva</b> size: 600 mm x Ø 38 mm base: G13 BL 368 nm (black light) Virgin FEP sleeve.	25 pcs	

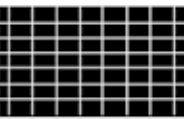
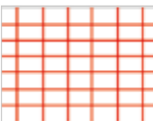
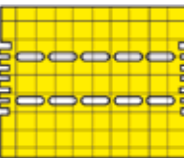

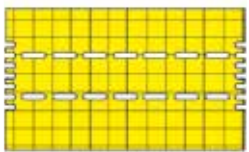

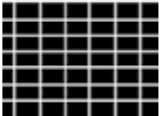
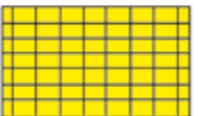
NEON

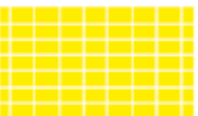
CODE		OUTER CARTON	
P-06018	<b>neon 18W lynx standard</b> size: 225 mm (lunghezza) base: 2G11 BL 368 nm (black light)	10 pcs	
P-06181SP	<b>neon 18W lynx shatterproof</b> size: 225 mm (lunghezza) base: 2G11 BL 368 nm (black light) Virgin FEP sleeve.	10 pcs	
P-06132	<b>neon 36W lynx standard</b> size: 406,4 mm x Ø 44,4 mm base: 2G11 BL 368 nm (black light)	10 pcs	
P-06171SP	<b>neon 36W lynx shatterproof</b> size: 406,4 mm x Ø 44,4 mm base: 2G11 BL 368 nm (black light) Virgin FEP sleeve.	10 pcs	
P-06129	<b>neon 20W mini lynx standard</b> size: 178 mm (lunghezza) base: E27 BL 368 nm (black light)	10 pcs	
P-06125SP	<b>neon 20W mini lynx shatterproof</b> size: 178 mm (lunghezza) base: E27 BL 368 nm (black light) Virgin FEP sleeve.	10 pcs	
P-06130	<b>starter FS22</b>	25 pcs	
<b>NEW</b> P-06189SPIN	<b>STARLED</b> TUBO LED UV T8 5W tube compatible with shatterproof inductive ballast measures: 451,6 mm x Ø 26 mm	25 pcs	
<b>NEW</b> P-06190SPIN	<b>MOONLED</b> TUBO LED UV T8 5W Compatible with shatterproof electronic ballast measures: 451,6 mm x Ø 26 mm	25 pcs	

CODE	GLUE BOARD NAME	MATERIAL	COLOR	GRID	DIMENSION	PCS/PACK	IMAGE
P-G06003FG2C	<b>MONITOR FLY DOUBLE</b>	carton	yellow	black	450x325mm	12	
P-G06003FN2C	<b>MONITOR FLY DOUBLE</b>	carton	black	white	450x325mm	12	
P-G06330FNC	<b>MONITOR FLY BASE DOUBLE</b>	carton	black	-	482x86mm	12	
P-G06044FGC	<b>MONITOR FLY MONO</b>	carton	yellow	black	450x325mm	12	
P-G06044FNC	<b>MONITOR FLY MONO</b>	carton	black	white	450x325mm	12	
P-G06329FNC	<b>MONITOR FLY BASE MONO</b>	carton	black	-	482x44mm	12	
P-I06355GC	<b>FLY VARIO</b>	carton	yellow	black	574x232mm	6	

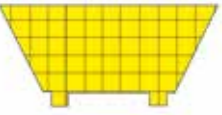
CODE	GLUE BOARD NAME	MATERIAL	COLOR	GRID	DIMENSION	PCS/PACK	IMAGE
P-B06128FSC	<b>COFFEE LIGHT</b>	carton	white	black	299x240mm	6	
P-G06199FGC	<b>ARACNO - COMMERCIAL</b>	carton	yellow	black	460x299mm	6	
P-G06199FNC	<b>ARACNO - COMMERCIAL</b>	carton	black	white	460x299mm	6	
P-G06064SC	<b>PST 30</b>	carton	white	red	465x345mm	10	
P-SF06060FGP0	<b>SPIDER PLASTIC 30</b>	alveolar plastic	yellow	black	445x364mm	6	
P-L06190SC	<b>PST 40</b>	carton	white	red	615x345mm	10	
P-SI06099FGP0	<b>SPIDER PLASTIC 40</b>	alveolar plastic	yellow	black	597x364mm	6	

CODE	GLUE BOARD NAME	MATERIAL	COLOR	GRID	DIMENSION	PCS/PACK	IMAGE
P-SE06062GC	<b>SPIDER 30</b>	carton	yellow	black	395x310mm	6	
P-SE06062NC	<b>SPIDER 30</b>	carton	black	white	395x310mm	6	
P-SH06061GC	<b>SPIDER 40</b>	carton	yellow	black	544x310mm	6	
P-SH06061NC	<b>SPIDER 40</b>	carton	black	white	544x310mm	6	
P-F06328FGC	<b>PARTY</b>	carton	yellow	white	420x241mm	6	
P-F06328FNC	<b>PARTY</b>	carton	black	white	420x241mm	6	
P-SI06078FGC	<b>SPIDER APLIQUE 2000</b>	carton	yellow	black	560x220mm	6	

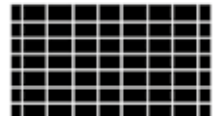
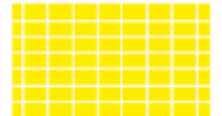
CODE	GLUE BOARD NAME	MATERIAL	COLOR	GRID	DIMENSION	PCS/PACK	IMAGE
P-SL06121FGC	<b>SPIDER APLIQUE PROFESSIONAL</b>	carton	yellow	nera	570x224mm	6	
P-SG06317FGC	<b>SPIDER APLIQUE PLUS</b>	carton	yellow	nera	476x193mm	6	
P-G06209FBC	<b>ULTRALIGHT APLIQUE 18 W</b>	carton	bianco	-	465x180mm	6	
P-SC06315GC	<b>SPIDER ROUND</b>	carton	yellow	nera	270x270mm	6	
P-F06156FNC	<b>MULTIBOARD</b>	carton	nero	white	418x283mm	15	
P-F06156FGC	<b>MULTIBOARD</b>	carton	yellow	white	418x283mm	15	

OTHER GLUE BOARDS AVAILABLE ON REQUEST, CONTACT YOUR SALES REPRESENTATIVE

# BIRD REPELLENT

## QUI NO

Bird displacement glue. Does not contain any toxic active substances. Must be applied on flat surfaces to prevent birds from landing and nesting on the treated area.

✓ CAN BE USED WITH A STANDARD SILICONE GUN.

CODE	P - 14006
CONTENT	250 g (8,8 oz)
PACK	1 pc
OUTER CARTON	Sales unit <b>12 pcs</b>
PALLET	960 pcs, 80x120x125H

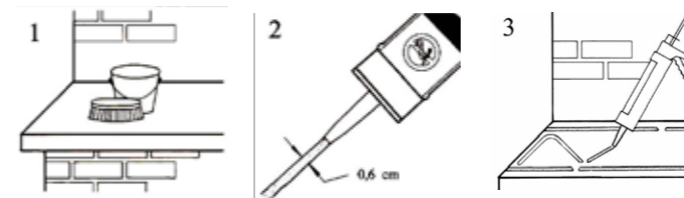

# SALES TERMS

## How to place an order

1. Send the order by e-mail to the following address: orders@geaitaly.it
2. The order must state the correct product identification code, the quantity and the agreed price for each item.
3. Minimum order quantity: 200€ (orders will be accepted for multiples of outer boxes i.e. the sales unit).
4. The customer will send a signed and stamped copy of the pro-forma invoice back to GEA for acceptance.

## Disclaimer

The material in this publication is for your general information only. Whilst GEA endeavours to ensure the accuracy and completeness of the contents of this publication, it does not accept any responsibility for loss occasioned as a result of reliance placed on any part of its contents. Your use of this publication is governed by the conditions of GEA. GEA reserves the rights to make changes to the products contained in the catalogue without prior notification. Products may be withdrawn or replaced in order to comply with changes to registrations or usage guidelines. Products may differ from images shown in catalogue and on website. E&OE.

# CUSTOMIZATION

## Products in this catalogue which are suitable for customization must comply to the following specifications:

- 1) Artwork must be provided by the customer
- 2) Artwork will be printed in maximum CMYK (no pantone colors unless stated otherwise)
- 3) Orders for custom products will not be accepted for volumes lower.
- 4) Quotations vary depending on technical requests (number of colors, quantity, etc.)
- 5) Lead Time 90 working days from Order Confirmation/ArtWork's approval
- 6) **Please contact us for further information**

# ALPHABETICAL INDEX

<b>#</b>		<b>G</b>		<b>R</b>	
3 way phero pack	31	galvanised tunnel	83	rat snap trap EVO	87
3 way trap	30	geo pad clothes blue	48	refill board mini	62
		geo pad food green	48	refill board maxi	62
<b>A</b>		geotrap	63	refill oil bottle	38
anobiidi trap	47	geotrap evo	63	refill flash paper	38
apple trap	93	geotrap mini	64	roach tab	18
apple dust	93	geotrap plastic	65	rock bait station	89
aracno	102			rodent stop transparent	89
		<b>I</b>		rufy trap	40
<b>B</b>		insect pad	65	rufy trap waterproof	40
bed bugs trap	68			<b>S</b>	
beta 2	88	<b>M</b>		scara4trap	64
bed bugs tape	68	magnetic trap	32	silvertrap Ag <sup>47</sup>	62
book refill	76	magnetic trap detectable	33	stop mini	74
		mass@ trap	49	stop mini plastic	77
<b>C</b>		metal hanger	103	store trap	46
cable tie MD <sup>2</sup>	58	monitor guard	66		
check point	26	monitor fly double shatterproof	100	<b>T</b>	
cerabile	58	monitor fly mono shatterproof	100	t-stop	75
coffee light evo	102	monitor fly led bifacciale	101	trap bag	95
coral	88	moth hanger	48	traptest	49
chromoplus wing	94	multi catch plastic	86	tunnel maxi	80
		multi catch metal	85	tunnel quadro mini	81
<b>D</b>		multispecies tab	20	twist tie MD <sup>2</sup> grey	54
detectable pen	58	multitrap	46	twist tie MD <sup>2</sup> blue	54
dermetes tab	18			<b>U</b>	
drosocyl	94	<b>N</b>		ultra stop	75
		neon	104-105	unibox	84
<b>E</b>		no target oil bottle	73	universal glueboard	74
easy bugs	67			universal gb plastic	77
easy trap	45	<b>O</b>			
easy trap phero pack	45	ovoposition stick	94	<b>V</b>	
ecotrap quadro mini	81			vespokil	93
ecotrap maxi black - white	79	<b>P</b>			
		piophilacyl	19	<b>W</b>	
<b>F</b>		politrap	50	waterproof trap	78
feromoni Phero-Si e attrattivi specifici	14-22	politrap gb	50	waterproof box	78
feromoni per la tecnica di confusione		protection cage	39	wire25	38
sessuale	24			wire59	38
flash oil phero pack	35	<b>Q</b>		<b>X</b>	
flash oil magnetic trap	36	qui no	111	xTrap Delta	44
flash oil magnetic trap detectable	36				
fly VARIO	99				

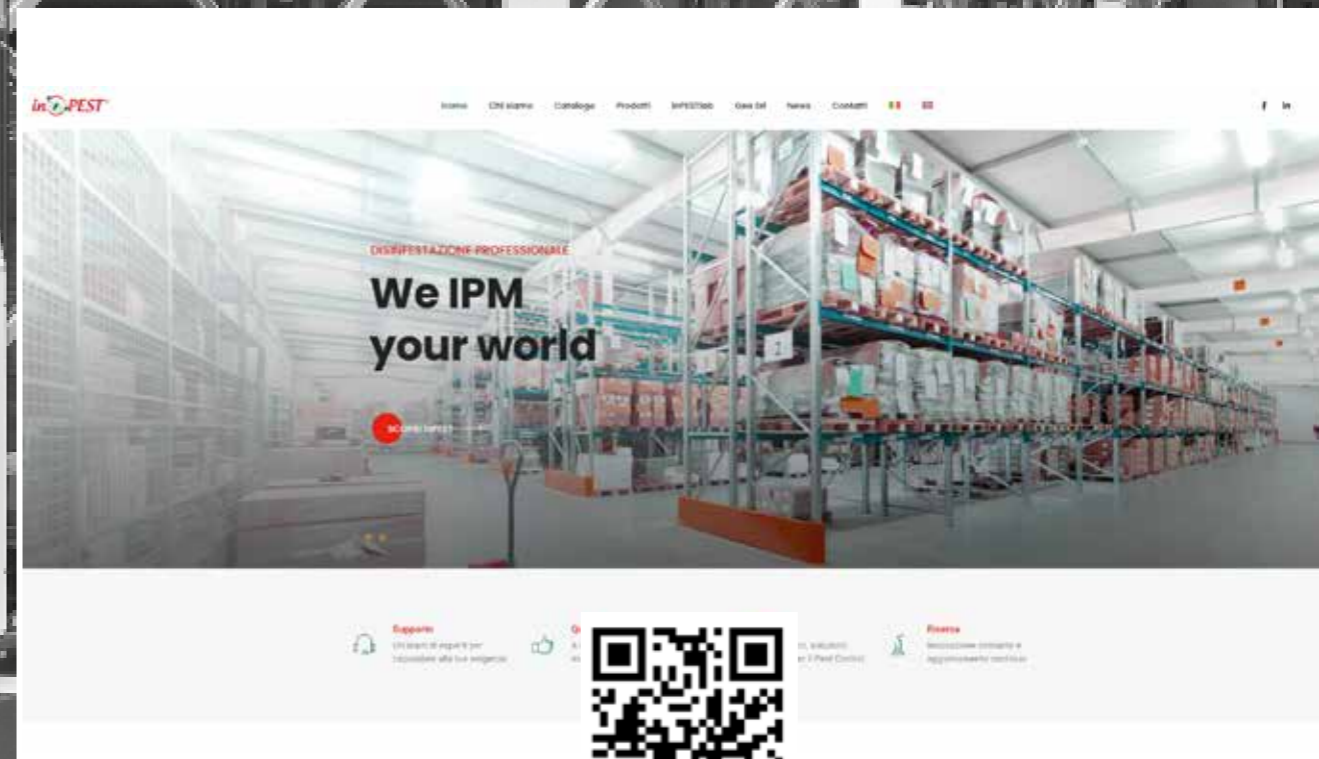

**Visit our website**  
<https://inpest.it/en/>

